

Winter 1-31-1994

## Study on the remediation of organic soil contaminated with polychlorinated biphenyls using a variable frequency microwave furnace

Lili Zou  
*New Jersey Institute of Technology*

Follow this and additional works at: <https://digitalcommons.njit.edu/theses>



Part of the [Environmental Sciences Commons](#)

---

### Recommended Citation

Zou, Lili, "Study on the remediation of organic soil contaminated with polychlorinated biphenyls using a variable frequency microwave furnace" (1994). *Theses*. 1712.  
<https://digitalcommons.njit.edu/theses/1712>

This Thesis is brought to you for free and open access by the Electronic Theses and Dissertations at Digital Commons @ NJIT. It has been accepted for inclusion in Theses by an authorized administrator of Digital Commons @ NJIT. For more information, please contact [digitalcommons@njit.edu](mailto:digitalcommons@njit.edu).

## Copyright Warning & Restrictions

The copyright law of the United States (Title 17, United States Code) governs the making of photocopies or other reproductions of copyrighted material.

Under certain conditions specified in the law, libraries and archives are authorized to furnish a photocopy or other reproduction. One of these specified conditions is that the photocopy or reproduction is not to be “used for any purpose other than private study, scholarship, or research.” If a user makes a request for, or later uses, a photocopy or reproduction for purposes in excess of “fair use” that user may be liable for copyright infringement,

This institution reserves the right to refuse to accept a copying order if, in its judgment, fulfillment of the order would involve violation of copyright law.

**Please Note: The author retains the copyright while the New Jersey Institute of Technology reserves the right to distribute this thesis or dissertation**

Printing note: If you do not wish to print this page, then select “Pages from: first page # to: last page #” on the print dialog screen

The Van Houten library has removed some of the personal information and all signatures from the approval page and biographical sketches of theses and dissertations in order to protect the identity of NJIT graduates and faculty.

## ABSTRACT

### STUDY ON THE REMEDIATION OF ORGANIC SOIL CONTAMINATED WITH POLYCHLORINATED BIPHENYLS USING A VARIABLE FREQUENCY MICROWAVE FURNACE

by  
Lili Zou

The development of new and innovative remediation technologies for soil contaminated with Polychlorinated Biphenyl (PCB) is necessary to fulfill the need of cleanup of contaminated sites. In the past eight years the Laboratory for Microwave treatment as Hazardous Substance Management Research Center has investigated the use of Microwave energy to remediate contaminated soils. A major drawback of using single frequencies of the microwave range is the non-uniformity of the electromagnetic field. In this thesis a Variable Frequency Microwave Furnace (operating between 2.40 and 7.50 GHz) is used to improve the uniformity of the field. A new method is used to map the field uniformity in a fixed and variable frequency furnace. Frequency ranges larger than 1 GHz lead to uniform field distribution. Soil with an organic content of 82% was contaminated with PCB congeners #53 and #65 to ca. 400 ppm, and subjected to microwave exposure. Extracts of blanks and treated samples were analyzed with GC/MS. No breakdown products were observed in any of the extracts. The reduction of PCB in the extract was not dependent on the length of exposure to microwave energy. Soil temperature had the greatest effect on the reduction efficiency in the extract: the reduction efficiency at 170°C averaged at 55%, at 100°C it was only 17% for PCB #53. In preliminary experiments no PCBs were detected in the offgas. Additional experiments have to investigate the fate of the PCB in the soil as the offgas.

**STUDY ON THE REMEDIATION OF ORGANIC SOIL  
CONTAMINATED WITH POLYCHLORINATED BIPHENYLS  
USING A VARIABLE FREQUENCY MICROWAVE FURNACE**

by  
**Lili Zou**

Robert W. Van Houten Library  
New Jersey Institute of Technology

**A Thesis  
Submitted to the Faculty of  
New Jersey Institute of Technology  
in Fulfillment of the Requirements for the Degree of  
Master of Science in Environmental Science**

**Department of Chemical Engineering,  
Chemistry and Environmental Science**

**January 1995**

APPROVAL PAGE

STUDY ON THE REMEDIATION OF ORGANIC SOIL  
CONTAMINATED WITH POLYCHLORINATED BIPHENYLS  
USING A VARIABLE FREQUENCY MICROWAVE FURNACE

Lili Zou

Dr. Richard Trattner, Thesis Advisor  
Professor of Chemistry and Environmental Science  
and Associate Chairperson and Graduate Advisor for  
Environmental Science, NJIT

\_\_\_\_\_  
Date

Dr. Gabriele Wladgasse, Committee Member  
Senior Research Associate, Adjunct Professor (NJIT)  
Hazardous Substance Management Research Center

\_\_\_\_\_  
Date

Dr. Somnath Mitra, Committee Member  
Assistant Professor of Chemistry, NJIT

\_\_\_\_\_  
Date

## BIOGRAPHICAL SKETCH

**Author:** Lili Zou

**Degree:** Master of Science in Environmental Science

**Date:** January 1995

### Undergraduate and Graduate Education

- Master of Science in Environmental Science,  
New Jersey Institute of Technology,  
Newark, New Jersey, 1995
- Bachelor of Science in Environmental Engineering,  
Beijing Polytechnic University,  
Beijing, P. R. China, 1984

**Major:** Environmental Science

This thesis is dedicated to Dr. Gabriele Windgasse



## ACKNOWLEDGMENT

I wish to express my deep appreciation and sincere gratitude to Dr. Windgasse, for her guidance, friendship, and moral support throughout this research. Her patience and dedication in assisting me with this thesis will always be remembered. I learned a great deal from her invaluable suggestion which I am certain will be extremely beneficial in my career.

Special thanks to Professor Richard Trattner for his generous suggestions throughout my master studies, and for making the completion of this degree possible.

Thanks to Dr. Mitra for serving as a member of the committee.

Also, I would like to express my gratitude to my family members, especially my parents for all their support.

## TABLE OF CONTENTS

Chapter	Page
1 INTRODUCTION.....	1
2 THE CHARACTERISTICS OF SOIL.....	3
2.1 The Properties of Soil .....	3
2.2 Absorption of Organic Chemicals on Soil .....	4
2.3 Soil Sorption of PCBs.....	6
2.4 Mobility of PCBs in Soils .....	7
2.5 Experiments on Vitahume Top Soil.....	7
2.5.1 Particle Size Distribution .....	7
2.5.2 pH.....	9
2.5.3 Moisture Content .....	9
2.5.4 Combustible Materials.....	10
3 HUMAN TOXICITY OF PCBs.....	11
3.1 Introduction .....	11
3.2 Physical and Chemical Property.....	11
3.3 Toxicity-Structure Relationship.....	12
3.4 Toxic Effect on Human .....	13
3.4.1 Subpopulation --Occupational Exposure.....	14
3.4.2 General Population .....	14
3.5 Evidence for Chronic Effects.....	15
3.5.1 Cacinogenicity and Related Studies in Animals .....	15
3.5.2 Epidemiological Studies of Humans.....	16
3.6 Workplace Exposure Limits .....	17
3.7 Precaution and Protection .....	17

**TABLE OF CONTENTS**  
(Continued)

Chapter	Page
4 REMEDIATION TECHNOLOGIES FOR PCBs CONTAMINATED SOIL .....	19
4.1 Introduction.....	19
4.2 Legal Aspects in PCBs Remediation .....	19
4.3 Soil Remediation Technology .....	20
4.3.1 Thermal Treatment .....	21
4.3.2 Chemical Treatment.....	22
4.3.3 Physical Treatment.....	22
4.3.4 Biological Treatment.....	23
5 MW ENERGY-- FIXED AND A VARIABLE FREQUENCY .....	24
6 MAPPING THE ELECTROMAGNETIC FIELD DISTRIBUTION IN A FIXED FREQUENCY MICROWAVE FURNACE .....	28
6.1 The Methods for Mapping Field Distribution Within a MW Cavity.....	28
6.2 The Field Distribution Mapping Method .....	30
6.3 Result and Conclusions .....	30
7 MAPPING THE ELECTROMAGNETIC FIELD DISTRIBUTION IN A VARIABLE FREQUENCY MICROWAVE POWER .....	36
7.1 Microwave Apparatus.....	36
7.2 The Power Distribution Mapping Method.....	38
7.3 Test, Results and Conclusions.....	39
8 THE ANALYTICAL PROCEDURE OF SOIL SAMPLE .....	43
8.1 Sample Preparation.....	43
8.2 MW Measurement.....	43
8.2.1 Selection of Reaction Vessels.....	43

**TABLE OF CONTENTS**  
(Continued)

Chapter	Page
8.2.2 MW Treatment Procedure.....	44
8.3 Extraction Procedure.....	44
8.4 Analytical Procedure.....	45
8.5 Calibration Curve .....	46
8.6 Quality Assurance and Quality Control .....	46
9 GC/MS ANALYSIS .....	53
9.1 Introduction to GC/MS .....	53
9.2 Main Properties of GC/MS.....	56
9.2.1 Detection Limit .....	56
9.2.2 The choice of Carrier Gas .....	57
9.2.3 The GC Column .....	57
9.2.4 Temperature programming .....	58
10 MW EXPERIMENTS WITH ORGANIC SOIL .....	61
10.1 Ratios of Forward Power to Reflected Power at Different Frequency Range .....	61
10.2 Measure the Time for Soil to Reach 100 °C in One GHz Frequency Range.....	61
10.3 Comparison of Extractability of Two Extraction Methods.....	63
10.3.1 Introduction .....	63
10.3.2 Instrument and Experimental Condition.....	63
10.3.3 Experimental I.....	64
10.3.4 Experiment II.....	64
10.3.5 Conclusion .....	65
10.4 Solvent Comparison with Ultrasonic Extraction Method .....	65

**TABLE OF CONTENTS**  
**(Continued)**

<b>Chapter</b>	<b>Page</b>
10.4.1 Experiment.....	65
10.4.2 Conclusion.....	66
10.5 Behavior of Soil Contaminated with PCB#53 in a Variable Frequency Microwave Field.....	66
10.5.1 Experiment.....	66
10.5.2 Conclusion.....	70
10.6 Behavior of Soil Contaminated with PCB#65 in a Variable Frequency Microwave Field.....	70
10.6.1 Experiment.....	70
10.6.2 Conclusion.....	73
10.7 Temperature Effect Experiments on Soil Contaminated with PCB#53.....	73
10.7.1 Experiment.....	73
10.7.2 Conclusion.....	76
10.7.3 Suggestion.....	76
APPENDIX A FIGURES OF CHAPTER 6.....	77
APPENDIX B FIGURES OF CHAPTER 7.....	88
REFERENCES.....	100

## LIST OF TABLES

Table	Page
2.1 Particle Size Partition of Organic Soil .....	8
2.2 Moisture Measurement Records (g) .....	9
2.3 Combustible Material Measurement Records (g) .....	10
6.1 The Temperature of the Load.....	32
6.2 The Water Temperature of Three Loaded Position (1 × 500 ml).....	33
6.3 Temperature Measurement of the Loaded Position (with Three Beaker of Water).....	34
6.4 Temperature Measurement of the Loaded Position (500 ml Water) .....	35
7.1 Records of Parameters in $\text{cw} = 2.45 \text{ GHz}$ (= fixed Frequency) .....	39
7.2 Records of Parameters .....	39
7.3 Records of Parameters in the Full Frequency Range ( $\text{sw} = 0.1 \text{ second}$ ).....	40
7.4 Records of Parameters in 1 GHz Range .....	41
7.5 Records of Parameters in Two GHz Range .....	41
7.6 Records of Parameters in 1 GHz with Different Positions 100 ml Load .....	42
8.1 Typical physical properties of Coors AD-998 crucible.....	44
9.1 Instrumental Methods and Their Characteristics .....	53
10.1 Time to Reach $100^{\circ}\text{C}$ in One GHz Frequency Range.....	61
10.2 Soxhlet Extraction Results on Stock Sample B.....	64
10.3 Soxhlet Extraction Results on PCB#53 Contaminated Soil .....	65
10.4 Two Extraction Method Comparison .....	65
10.5 Solvent Comparison by Ultrasonic Extraction on PCB#53 Soil Sample.....	66
10.6 MW Treatment Condition on PCB#53 Soil (First and Second Measurement) .....	67
10.7 First Batch of Experiment on PCB#53 Soil Sample .....	68

**LIST OF TABLES**  
**(Continued)**

<b>Table</b>	<b>Page</b>
10.8 Second Batch of Experiments with PCB#53 Soil Sample.....	69
10.9 Reduction of Extractable PCB#53 in MW Treatment .....	69
10.10 MW Treatment Conditions on soil Contaminated with PCB #65 ( First and Second Measurement).....	70
10.11 First Experiment with PCB#65 .....	71
10.12 PCB #65 Soil Extraction and MW Treatment Result in the Second Experiment .....	72
10.13 Reduction of Extractable PCB#65 in MW Treatment .....	72
10.14 The Relation of Sweeprate and Heating Rate.....	73
10.15 Experiments of the Temperature Effect (2.4--7.5 GHz) .....	74
10.16 Redcution Efficiency (%) of PCB#53 at Different Temperatures.....	75

## LIST OF FIGURES

Figure	Page
1.1 General Structure for PCBs .....	2
2.1 Particle Size Partition of Vitahume Top Soil .....	8
6.1 Illustration of MW Cavity and Load Position .....	29
6.2 Illustration of Test Approach .....	30
6.3 Cross Section of Two Layers of Thermal Paper .....	31
6.4 Cross Section of Three Layers of Thermal Paper .....	33
6.5 Illustration of one Breaker Position .....	33
6.6 Illustration of Three Beaker Positions .....	34
6.7 Illustration of Load Position (500ml Water) .....	34
7.1 The Model T-4001 Variable Frequency Microwave Furnace .....	37
7.2 Block Diagram of the Variable Frequency Microwave Furnace .....	37
7.3 Illustration of Test Approach .....	38
7.4 Illustration of Load Position .....	39
8.1 Tune File .....	48
8.2 Acquisition File .....	49
8.3 Integration File .....	50
8.4 TIC and SIC Spectra Of PCB#65 .....	50
8.5 Calibration Curve For PCB#65 .....	51
8.6 Calibration Curve For PCB#53 .....	52
9.1 Block Diagram of Typical GC/MS System .....	54
9.2 Schematic Diagram of GC.....	55
9.3 TIC Spectrum of Aroclor 1260 .....	60
9.4 Library Search Result for One Peak in Aroclor 1260 in Hexane .....	60



**LIST OF FIGURES**  
(Continued)

<b>Figure</b>	<b>Page</b>
10.1 Ratios of Forward Power to Reflected Power .....	62
10.2 TIC and SIC of Glass Wool and Glass Bead Extract Solution.....	75
10.3 Reduction Efficiency of Extracyttable PCB#53 Varing Tendency with Temperature.....	75
A.1 A thermal Paper Between Two Styrofoam Blocks ( 20 seconds) .....	78
A.2 A Carbon Paper with Two Thermal Paper and Plus Styrofoam Blocks (20 seconds ) .....	78
A.3.1 The Top Layer of Thermal Paper (20 seconds ) .....	79
A.3.2 The Bottom Layer of Thermal Paper (20 seconds ).....	79
A.4.1 The Top Layer of Thermal Paper (20 seconds ) .....	80
A.4.2 The Middle of Thermal Paper (20 seconds ) .....	80
A.4.3 The Bottom Layer of Thermal Paper ( 20 seconds ).....	81
A.5.1 The Load Volume =150 ml (3 min.) .....	81
A.5.2 The Load Volume =300 ml (3 min.) .....	82
A.5.3 The Load Volume =400 ml (3 min.) .....	82
A.5.4 The Load Volume =500 ml (3 min.) .....	83
A.6.1 The Load with 500 ml in Position (a) (3 min.) .....	83
A.6.2 The Load with 500 ml in Position (b) (3 min.) .....	84
A.6.3 The Load with 500 ml in Position (c) (3 min.) .....	84
A.7.1 The Load with 3x150 ml in Position (a) ( 5 min.).....	85
A.7.2 The Load with 3x150 ml in Position (b) ( 5 min.) .....	85
A.7.3 The Load with 3x150 ml in Position (c) ( 5 min.).....	86
A.8.1 The Load with 500 ml ( 7 min.).....	86
A.8.2 The Load with 2x250 ml (7 min.) .....	87

**LIST OF FIGURES**  
(Continued)

<b>Figure</b>	<b>Page</b>
A.8.3 The Load with 5x100 ml ( 7 min.) .....	87
B.1 cw=2.45 GHz. Exposure Time = 40 sec. ....	89
B.2 cw=2.45 GHz.Exposure Time = 30 sec. ....	89
B.3 cw=2.45 GHz Exposure Time = 25 sec .....	90
B.4 cw=2.45 GHz The Load with 100 ml Water in Position(a), Exposure time = 25 sec. ....	90
B.5 cw=2.45 Ghz. The Load with 100 ml Water in Position (b) Exposure time =25 sec. ....	91
B.6 2.40--7.5 GHz , cw=2.45 GHz.. The Load with 100 ml Water in Position (c) Exposure Time =25 sec. ....	91
B.7 2.40--7.5 GHz , sw=0.1sec. Exposure Time =40 sec. ....	92
B.8 2.40--7.5 GHz, sw=0.1sec. The Load with 100 ml Water in Position (a). Exposure Time =40 sec.....	92
B.9 2.40--7.5 GHz , sw=0.1sec. The Load with 100 ml Water in Position (b). Exposure Time =40 sec. ....	93
B.10 2.40--7.5 GHz , sw=0.1sec. The Load with 100 ml Water in Position (c) Exposure Time =40 sec.....	93
B.11 4.5--5.5 GHz, sw=0.1 sec.. Exposure Time =40 sec. ....	94
B 12 5.5--6.5 GHz, sw=0.1 sec.. Exposure Time =40 sec .....	94
B.13 6.5--7.5 GHz, sw=0.1 sec.. Exposure Time =55 sec .....	95
B.14 4.5--6.5 GHz, sw=0.1 sec.. Exposure Time =1 min.....	95
B.15 5.5--7.5 GHz, sw=0.1 sec..Exposure Time =1 min.....	96
B.16 4.5--5.5 GHz sw=0.1 sec.. Exposure Time =2 min. Two layers of Teledeltos Paper at Different Height. ....	96
B.17 4.5--5.5 GHz sw=0.1 sec.. Exposure Time =1 min.....	97

**LIST OF FIGURES**  
**(Continued)**

<b>Figure</b>	<b>Page</b>
B.18 4.5--5.5 GHz sw=0.1 sec.. Exposure Time =40 sec. ....	97
B.19 4.5--5.5 GHz sw=0.1 sec..The Load with 100 ml Water in Position (a) Exposure Time =40 sec.....	98
B.20 4.5--5.5 GHz sw=0.1 sec. The Load with 100 ml Water in Position (b). Eexposure Time =40 sec. ....	98
B.21 4.5--5.5 GHz sw=0.1 sec.. The Load with 100 ml Water in Position (c). Eexposure Time =40 sec.....	99

## CHAPTER 1

### INTRODUCTION

Polychlorinated Biphenyls (PCBs) have been in the forefront of public and scientific focus for over 20 years. Their presence and persistence has been a matter of concern ever since. TSCA regulations stipulate landfill and incineration as the acceptable options for PCBs. The design and criteria and destruction targets for PCB disposal are more stringent than other hazardous wastes under RCRA. Soil treatment technologies have encountered greater difficulty in meeting these standards. There is need for alternative technologies which are distinguished from incineration. The major objective of this research is to apply microwave technology to remediating PCB congeners from organic top soil at a relative low temperature. A Variable Frequency Microwave Furnace (VFMF) is employed to treat PCBs in soil.

This laboratory has been involved with the development of microwave - assisted processes to treat contaminated soil. Three processes have been defined: (1) Microwave-assisted steam distillation of volatiles; (2) Microwave-assisted "fixation" of non-volatile, insoluble organics; (3) Microwave-assisted "fixation" of toxic heavy metals. A fixed energy MW furnace (2450 GHz) was employed in previous laboratory researches. The uniformity in the fixed energy MW furnace is very poor, In this thesis, we utilize a mapping method for the electromagnetic field in a fixed frequency setting, and the experimental results have indicated non- uniformity of the field. The uniformity in MW cavity has been greatly enhanced by using the VFMF, in which different regions in the cavity were uniformly exposed to MW energy within a few milliseconds.

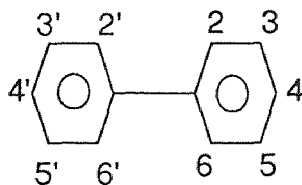

Figure 1.1 General structure for PCBs

From the general structures of PCBs: It can be seen that the many variations in number and positions of attached chlorine atoms make 209 different structures possible. Only two congeners, PCB#53 and PCB#65, were used to contaminate organic soil. Ultrasonic extraction is employed for PCB extraction, from soil. GC/MS is used to analyze the concentration of PCB congeners in the extract.

A brief discussion and experiments are given in Chapter 2 about the properties of organic soil and experiments on the particle size distribution, moisture content, pH and combustible material contents of commercial available Vitahume top soil. Chapter 3 deals with PCB toxicity on humans, which describe the physical, chemical, and toxicological properties of PCBs and collect particular evidences on occupational exposure, general population, carcinogenicity studies in animals and epidemiological studies of humans. In Chapter 4, a review of the current remediation technologies of PCBs from soil is given. Analytic procedures are described in Chapter 8. The major portion of thesis is the GC/MS analysis of the soil extracts and is presented in Chapter 9, which discusses the main properties of GC/MS and show the parameters used in this research. Experiments with PCB organic soil is given in Chapter 10. The results and conclusion are respectively given in Chapter 11 and Chapter 12.

## CHAPTER 2

### THE CHARACTERISTICS OF SOIL

#### 2.1 The Properties of Soil

Soil is a mixture of mineral matter, organic matter, water and air. The mineral and organic components vary greatly from one soil to another but remain relatively constant in any particular soil. Four physical properties, texture, structure, quantity and arrangement of water, and color are recognized in all soils. These physical properties are readily detected through the senses of sight and touch (Gibson, 1970).

Texture is the fineness and coarseness of soils. The four principal size categories are 'gravel', 'sand', 'silt', and 'clay'. Many soil qualities are closely related to texture, the rate and extent of many physical and chemical reactions in soils are governed by texture, which defines the extend of surface area (Gibson, 1970).

Structure is the arrangement of soil particles in aggregates. It is much more complex than texture. Physical, chemical, and biological forces in nature work together to form soil particles into a great variety of structure patterns.

Water is the most variable property of soil, soil water is a very significant factor in planting, tilling, and housing cultivated crops, and soil chemistry. Several layers of water molecules are strongly absorbed to the soil particles basically because of these adhesive forces. Adhesion results in a spreading of water over the surface of the soil particles as a film when liquid water comes in contact with dry soil particles. The adsorption of water on the surface of soil particles produces (1) a reduction in the motion of the water molecules, (2) a reduction in the energy content of the water and (3) release of heat associated with the transformation of water to a lower energy level. Adhesion water is always present in the normal soil (even in the dust of the air). It moves little, but it cannot be moved by drying the soil in an oven (Foth, and Turk, 1972).

Beyond the sphere of strong attraction of the soil particles, water molecules are held in water film by cohesion (H bonding between water molecules). This outer film water is called cohesion water. Molecules of cohesive water compared to adhesive water, are in greater motion, have a higher energy level, and move more readily. The water film (including adhesion and cohesion water) in soils may be as much as 15 to 20 molecular layers thick. The outer approximately two-thirds of the film can be considered available to plants and constitutes the major source of water for plant growth. (Foth, and Turk, 1972).

Color is helpful key to soil conditions. Soil ranges in color from white to black. But the most common colors are the different shades of red, yellow, and brown. These color indicates the different degrees of hydration and the concentration of iron and aluminum oxides which coat or strain the soil grains ( Gibson, 1970).

## 2.2 Absorption of Organic Chemicals on Soil

Vitahume top soil in this experiment was used to be contaminated by PCB#65 and PCB#53 respectively, this organic soil is a ready-to-use growing medium to replace or supplement regular soil for gardens and lawns. Its major functions are to help loosen hard soil, improve soil's ability to retain water and to enhance germination of grass and garden seeds.

The organic portion of soil results from the decay of plant and animal biomass. Hundreds of organic pesticides are now on the market, being sold in thousands of various formulations. The absorption of organic chemicals on soil is essential for the assessment of the fate of organic chemicals in the environment and potential adverse impacts. The extent to which an organic chemical is absorbed is determined by the chemical's structure and the soil's physical and chemical properties (Gibson, 1970).

Organic compounds become sorbed to the various constituents of soil, which include primarily clay minerals, indigenous organic matter, and occasionally amorphous

oxides-hydroxides of metals. Clay minerals are two - and three-sheet layered silicates composed mainly of silica tetrahedral and octahedral structures. Sorption of organics onto clay minerals influences the thickness of diffuse double layer of clay domain, which can effect the physical properties of the clay, including its hydraulic properties, which could in turn affect the sorption ( and desorption ) rates (O'Neill, 1993).

Sorption onto amorphous compounds within the soil and indigenous organic matter appears to be largely pH dependent. Hydrophobic organic compounds such as chlorinated hydrocarbons can sorb onto these materials (O'Neill, 1993).

Sorption is an important mechanism of mass transfer. Sorption and aqueous-vapor equilibrium of the organic compound in the soil environment determine the amount of the compound that is in each phase (soil, aqueous, and vapor). The properties of the organic contaminant compound and the solvent medium also influence the sorption process. The most important broad characteristic of the organic contaminant is its ionic nature (ionic-cationic, acidic or basic, or nonionic-such chlorinated hydrocarbon. If the solvent medium is water, such that organic molecules that move by diffusion to adsorption sites must compete with the polar water molecules (O'Neill, 1993)

Chemical structure determines the magnitude of the organic chemical gross properties such as molecular volume, water solubility, octanol-water partition coefficient ( $K_{OW}$ ), and vapor pressure that influence the overall adsorptive behavior of the chemical. There are six aspects of chemical structure that govern adsorption.

(1) Molecular size

The larger the molecule, the greater its propensity to exist in the adsorbed state.

(2) Hydrophobicity

Soil mineral surfaces possess hydrophobic regions that can preferentially accumulate organic chemicals. Several inorganic particle surfaces, especially clay, also govern the extent of adsorption of various organic chemicals.



## (3) Molecular charge

Some organic molecules have intrinsic positive or negative charge .

## (4) Hydrogen bonding

a) A polar organic molecule is linked to an adsorbed cation through a water molecule

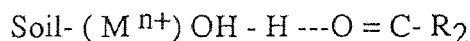

b) Hydrogen bonding can occur between an organic cation and another organic molecule:

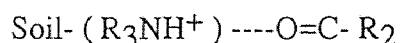

c) Hydrogen bonding can occur between organic molecule fragments and the oxygen and hydroxyl groups on the surface of the soil particles.

## (5) Arrangement and interaction of molecular fragments

The three dimensional arrangement of molecular fragments that comprise an organic chemical also can have a significant effect on its adsorption potential.

## (6) Coordination

For example, the oxygen of the nitro group on nitrobenzene can displace coordinated water molecules and become directly coordinated to adsorbed  $\text{K}^+$  and  $\text{NH}_4^+$  (Zhu, 1991)

### 2.3 Soil Sorption of PCBs

Soil, sludge solids, and lake sediments are excellent sorbents for PCBs because of their high organic content surface area, active surface properties, and functional groups. The higher chlorinated PCB congeners sorb more readily than the lower chlorinated species. This is thought to be hydrophobic sorption, which is the partitioning of the non-polar solute from the polar aqueous phase onto a hydrophobic soil phase that is primarily associated with soil organic matter. The interaction of PCBs dissolved into water may be so weak as to acquire the nature of a repulsion of the PCB molecule from the water. The more hydrophobic the PCB species, the greater the sorption onto a hydrophobic phase. The hydrophobic tendency is indicated by low water solubility and a high octanol-water partition coefficient. Soil pH affects the sorption capacity of organic matter. Soil moisture

content affects the soil sorption of organic contaminants and their volatilization (Gan, 1994 ).

## **2.4 Mobility of PCBs in Soils**

The movement of PCBs in soil profiles is directly proportional to the solubility of PCBs in the solvent and inversely proportional to the organic matter content of the soil. PCBs are nonpolar and , therefore, are sparingly soluble. In a polar solvent like water, the penetration of PCBs into the soil profile by water flow is extremely limited ( Gan, 1994 )

## **2.5 Experiments on Vitahume Top Soil**

The analysis of characteristics of Vitahume top soil is as follows:

### **2.5.1 Particle Size Distribution**

Particle size analysis is the measure of the proportions of the various sizes of primary soil particles determined usually either by their capacities to pass through sieves of various mesh size or by their rates of setting in water. The proportions are usually represented by the relative weights of particles within stated size classes. The limits of these size classes differ in various commonly used systems of soil particle size classification (Carter, 1993).

The following systems are commonly used:

- CSSC ( Canada Soil Survey Committee )
- USDA ( United States Department of Agriculture)
- Unified
- AASHO ( American Association of Highway Officials)

The particle size in the soil sample should be determined first ( this step depends on purpose of this experiment). A certain amount of soil were placed in the hood over several days to dry soil in the air before sieving, US standard testing sieves (ASTM E-11)

and A variable amplitude test shaker (ENDCOTT's Octagon 200 test sieve shaker) are used to obtain the size partitioning in this experiment (Table 2.1).

**Table 2.1** Particle Size Partition of Organic Soil

Size of particles (mm)	Aperture (mm)	Mesh	Mass (g)	% of total sample
>5.6 A	5.6	3 1/2	121.85	11.4 %
<5.6, >1.0 B	1.0	18	716.75	67.2 %
<1.0, >0.25 C	0.25	60	228.12	21.4 %
<0.25, >0.053	0.035	270	<1.0	----
Total			1066.72	100.0

The particle size distribution of Vitahume top soil was shown in Figure 2.1. This matrix can be characterized as fine sand by Unified system. The medium size particles between 5.6 and 1.0 mm (stock sample B) which is chosen to be the representative of the organic soil will be used to do the whole experiments .

### Particle Size of Vitahume Top Soil

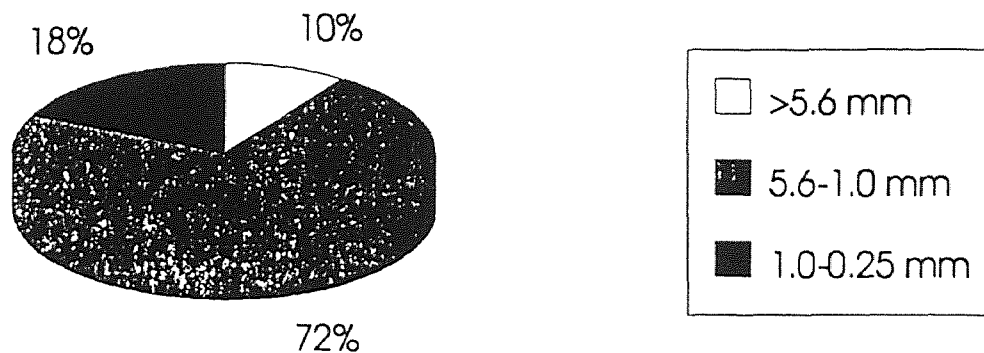

**Figure 2.1** Particle size of Vitahume top soil

### 2.5.2 pH

Three samples of 50g each were removed from "stock sample B" and 50 ml distilled water were added to each sample, After stirring and equilibration the slurry was vacuum filtered and the pH of the filtrate was uniformly 7.0 (Baxter Scientific products, Cat P1119-1A, S/P TM pH Indicator Strips).

### 2.5.3 Moisture Content

Equipments employed in measuring the moisture content:

- Two porcelain dishes I, II (I--Cermics, DFC; II--Coors combustible boat)
- Mettler AE 100 Balance
- Subside of SYBEON type 10500 Furnace -- Thermelyne (Muffle furnace)
- NALGENE desiccator

Two tarred porcelain dishes were filled with soil from " stock sample B "; the weight was noted and the dishes placed in a muffle furnace for 66 hours at 150 °C . They were cooled under vacuum in a desiccator to room temperature and weight again (Table 2.2). The weight loss was attributed to water loss. The average of the two dishes revealed a moisture content of 44.25 % of the original stock sample .

From the previous experimental data, the moisture level of sandy soil was 3.0%-- 8.5%, the moisture of clay soil was 4.9% -- 8.1% (Zhu, 1991). The value of moisture content varies greatly, because different soil constituents.

**Table 2.2** Moisture Measurement Records (g)

Porcelain dish	Before heating		After heating		Moisture content (%) (W-W')/ W × 100
	W <sub>tare</sub>	W <sub>soil</sub>	W <sub>(dish+soil)</sub>	W' <sub>soil</sub>	
I	10.8378	9.9654	16.3028	5.465	45.16
II	46.1244	28.0360	62.0084	15.884	43.44
Average					44.25

### 2.5.4 Combustible Materials

The dried and desiccated soil was reinserted in the muffle furnace at 600 °C for 72 hours and 900°C for 24 hours, then the samples were cooled to 110 °C overnight and cooled under vacuum in a desiccator to room temperature and weight again (Table 2.3). The resulting weight loss was attributed to combustible materials and was found to be 81.84 % of the original stock sample at room condition.

**Table 2.3** Combustible Material Measurement Records (g)

Porcelain dish	Initial weight (dish+soil)	Final weight (dish+soil)	Initial weight w(soil)	Final weight w'(soil)	Combustible material $(w-w')/w \times 100$ (%)
I	16.3028	15.2745	5.465	1.0283	81.18
II	62.0084	59.2276	15.884	2.7808	82.49
Average					81.84

## CHAPTER 3

### HUMAN TOXICITY OF PCBs

#### 3.1 Introduction

PCBs are a mixture of chemicals used in a wide variety of manufacturing processes, notably in the plastics industry, and as insulators in electrical capacitors, and transformers, plasticizers in waxes and for a variety of other industrial purposes. The production of PCBs in large quantities began in 1929. Between 1930 and 1975, approximately 1,253 million pounds of PCBs were produced for sale in the United States. It is estimated that 965 million pounds (77 % of the total) were used in electrical equipment (Darmiento, 1994). There are significant amounts of PCB contamination in the environment due to previous leaks and spills from equipment. Therefore, it is very important to know what PCBs are, how they affect human beings and how to protect yourself when you work on PCBs.

#### 3.2 Physical and Chemical Property

PCBs are a class of synthetic chlorinated organic compounds with biphenyl as the basic structural unit. Chlorination of the group can produce 209 possible PCB congeners, substituted with 1 to 10 chlorine atoms which contain 12 to 68 percent chlorine (by weight) having the formula  $C_{12}H_{10-n}Cl_n$  (Figure 1.1). PCBs are widespread, persistent, resistant to oxidation, acids, bases and chemical agents. PCBs have very low solubility in water, and very low vapor pressures, thermal stability, non flammability and high dielectric capability. All PCBs are soluble in oils and organic solvents. Photochemical degradation may be one route of their breakdown in the environment.

### 3.3 Toxicity-Structure Relationship

Most bioaccumulating PCB congeners have five to seven chlorinated atoms per molecule, which contain 112 out of 209 possible congeners. The more highly chlorinated congeners are generally less available to organisms both because they are more tightly bound with soils and sediments and because they usually are present in lower quantities in the environment. Congeners with less chlorination are more readily metabolized and eliminated and so do not tend to bioaccumulate as highly. Many PCBs congeners have never been reported in environmental samples, are not toxic, or have low bioavailability (McFarland and Clarke, 1989). It is reported that larger molecules tend to be less soluble in octanol. They also may be less soluble in the lipids of organisms. Such large volume molecules (e.g., the PCBs) may partition less easily into sites of toxic action within cells. Kinetic factors also influence acute toxicity, and larger molecules may take longer to establish concentrations necessary to produce toxic manifestations because of their lower diffusivity in water and lipid phases (McFarland & Clarke, 1989). The effectiveness of specific PCB congeners as inducers of different types of cytochrome p-450-dependent mixed-function oxidase (MFO) system is determined by their stereochemistry. Congeners that demonstrate 3-methylcholanthrene (3-MC) and MMFO induction have the greatest toxic potential, Weak inducers and noninducing congeners have the least potential for toxicity. The most toxicologically active PCB congeners are those have chlorine substitution at the 4 and 4' and at least 3, 3', 5 and 5' positions on the biphenyl nucleus, but no 2,2', 6 and 6' Substitutions (McFarland & Clarke, 1989). The phenyl rings of a PCB are not stay in the same plane, increasing the number of chlorine at the 2, 2', 6 and 6' points steric hindrance to rotation, but the number 138 (2, 2', 3, 4, 4', 5) and 153 (2, 2', 4, 4', 5, 5') have the greatest potency among 2, 2' coplanar congeners, both as inducers and as potential toxicants. It is reported that 36 congeners are considered most environmentally threatening based on their frequency of occurrence in environmental

samples, relative abundance in animal tissues and potential for toxicity (McFarland & Clarker,1989).

### 3.4 Toxic Effect on Human

People could potentially acquire PCBs from three sectors of the environment - air, water, food.

- 1) Absorption of PCBs in the air through the lung walls (inhalation).
- 2) Similar uptake from atmosphere but through the epidermis(dermal contact), If there are PCBs spills from equipment , solid or liquid of PCBs may contact with human skin.
- 3) Consumption of food containing PCBs and passage through the stomach walls (ingestion).

The third way is the major route for general population to expose to PCBs, the major route of occupational exposure to PCBs is through skin and lung.

Target Organs include Skin, liver, eyes, mucous membrane and respiratory tract. PCBs are potent liver toxins that can be absorbed through unbroken skin in toxic amounts without immediate pain or irritation, PCBs have low acute toxicity, but can accumulate in fatty tissue and severe health effects may develop later. Generally, toxicity increases with a higher chlorine content; PCB-oxides are more toxic. The toxic action on the liver also increases with simultaneous exposure to other liver toxins, e.g. chlorinated solvents, alcohol, and certain drugs. Pathological pregnancies (abnormal pigmentations, abortions, stillbirths, and underweight births) have been associated with increased PCB serum levels in mothers; PCBs can be passed in breast milk. PCBs can affect the reproductive system of adults. Medical conditions aggravated by long-term exposure: skin, liver, and respiratory disease.

Acute effects of exposure to PCB vapor or mist is severely irritating to the skin, eyes, nose, throat, and upper respiratory tract. Intense acute exposure to high concentrations may result in eye, lung, and liver injury. Systemic effects include nausea,



vomiting, increased blood pressure, fatigue, weight loss, jaundice, edema and abdominal pain. Cognitive, neurobehavior and psychomotor impairment and memory loss have also been seen after acute exposure.

Chronic effects of repeated exposure to PCBs can cause chloroacne; redness, swelling, dryness, thickening and darkening of the skin and nails; swelling and burning of the eyes, and excessive eye discharge; distinctive hair follicles; gastrointestinal disturbances; neurological symptoms including headache, dizziness, depression, nervousness, numbness of the extremities, and joint and muscle pain; liver enlargement; menstrual changes in women; and chronic bronchitis. Cancer, primarily liver, is also a possible result of exposure, but data is inconclusive (MSDS, Revision: A,9/92).

In order to further exhibit the PCBs chronic toxicity in human, two exposure situations are shown:

### **3.4.1 Subpopulation --Occupational Exposure**

It was reported that 11 healthy workers employ for 4 years in a capacitor factory in Finland, where Aroclor 1242 had been used as the impregnating fluid, had a concentration of PCBs in their blood (0.07-1.9  $\mu\text{g} / \text{g}$  ) that was approximately 50 times greater than that of a group with no particular exposure to PCBs (0.003-0.012  $\text{ug} / \text{g}$ ). The PCB pattern in the exposed workers differed markedly from the pattern of the PCB used; small amounts of the components contained in Aroclor 1254 were present in the Aroclor 1242 used. Consequently, the total PCB intaken must have been higher than that reflected by the levels detected in body (IARC, 1978 ).

### **3.4.2 General Population**

The majority of people are exposed to PCBs *via* the diet. One survey of food purchased in a local market in Japan indicated that a total PCB intake from prepared food varied

from 3.8-50 ug / person / day. An average of 80 % of the weekly intake of PCBs was from fish, 6 % from meat and 6 % from eggs.

Fish accumulate PCBs to more than 100,000 times the level present in water. In Japan, in 1972, more than 1 ug / g was found in the fresh, edible parts of 16 % of sea-water fish and in 18 % of fresh-water fish. Fish from the most highly polluted localities contained more than 3 ug /g PCBs (IARC monographs vol. 18). Fish from the upper Hudson River and Lake Ontario have been found to contain PCB concentrations from 5 to 20 ppm. Fish from a number of other rivers throughout the United States have also been found to contain comparable quantities of PCBs.

Human exposure to PCB has been reported in Japan and China where PCB-contaminated rice oil was consumed. In Japan (Yusho accident), PCB-exposed individuals exhibited chloracne and were more susceptible to respiratory infections. Decreased serum Ig levels were also observed. In a clinical study of individuals exposed to PCB-contaminated rice oil in China, a decreased delayed-type cutaneous hypersensitivity (DTH) response to *Streptococcus* antigens was observed as well as altered T-cell numbers and function (Klaassen, et al. 1986).

### 3.5 Evidence for Chronic Effects

#### 3.5.1 Carcinogenicity and Related Studies in Animals

In order to determine how the effects of PCB depend on exposure levels, all studies involve administration of a series of doses. To investigate how the effects of PCB depend on duration of exposure, PCB are administered for long periods. To determine how effects may depend on the characteristics of test organism, the PCBs is administered to both sexes of two or more species. To identify the cells and tissues that are effected by the PCB, broad range of endpoints are evaluated for PCB induced changes.

Mouse: Groups of 128-week-old male mice were administered Kanechlor (trade name of PCBs in Japan) 300, 400 or 500 at concentrations of 100, 250 or 500 mg /kg of

diet for 32 weeks: 6 control mice received the basal diet. After 32 weeks; 7/12 mice given 500 mg / kg Kanechlor 500 had liver nodules; 5 of these were hepatocellular carcinomas. No metastases or tumours were seen in other organs, and no tumours occurred in the other groups ( IARC, 1978).

Rat: A group of 10 male and 10 female 10-week-old Donryu rats were feed 38.5-616 mg Kanechlor 400/ kg of diet for 400 days; a control group of 5 males and 5 females received a basal diet. Multiple adenomatous nodules of the liver were observed in 6/10 treated females; these lesions did not occur in male rats nor in the controls (IARC Monographs vol. 18)

### **3.5.2 Epidemiological Studies of Humans**

Epidemiological studies seek to determine whether or not correlations exist between the frequency or prevalence of a disease or health condition in human populations and some specific factor such as concentration of PCB in the environment.

Retrospective mortality studies in 2567 workers (>3 months employment) from two capacitor manufacturing plants indicated that the mortality of the workers in both plants was lower than the control groups, and there were no significant increases in either liver or rectal cancer. An update of the mortality study in which seven additional years had elapsed, and therefore there were more deaths in the exposed group, did not alter the initial findings (Kirk-Othmer, vol. 6).

Numerous epidemiological studies of humans, both occupationally exposed and nonworker environmentally exposed populations, have not demonstrated any statistically significant causal relationship between PCB exposures and chronic human illnesses such as cancer or neurological or cardiovascular effects. Nor was there any increase in overall cancer mortality as a result of PCB exposure. PCBs can cause dermatological symptoms; however, these are reversible upon removal of exposure source.

There is some evidence that they cause skin cancer in humans.

### 3.6 Workplace Exposure Limits

OSHA: The legal airborne permissible exposure limit (PEL) is  $1 \text{ mg} / \text{m}^3$  (42% chlorine) and  $0.5 \text{ mg} / \text{m}^3$  (54 % chlorine) averaged over an 8-hour workshift.

NIOSH: The recommended airborne exposure limit is  $0.001 \text{ mg} / \text{m}^3$  averaged over a 10-hour workshift.

- The above exposure limits are for air levels only. When skin contact also occurs, you may be overexposed, even through air levels are less than the limits listed above.
- Polychlorinated biphenyls are probable cancer-causing agents in humans. there may be no safe level of exposure to carcinogens, so all contact should be reduced to the lowest possible level (HSFS, 1989)

### 3.7 Precaution and Protection

- (1) When the clothing has been contaminated by PCBs, it should be changed into clean clothing as soon as possible.
- (2) Preparing shower facilities.
- (3) Wear protective gloves, if the glove is accidentally broken, skin will contact with PCBs, immediately wash or shower to remove them with large amounts of soap and water and avoid the use of organic solvents to clean the skin. For reddened or blistered skin, consult a physician.. finally wash the whole body.
- (4) All protective clothing (suits, gloves, footwear, head gear) should be clean , available each day.
- (5) Eye and respiratory protection: At any exposure level, use a OSHA/NIOSH approved supplied - air respirator with a full facepiece, hood, or helmet in the lab. If eye contact with PCBs, immediately flush wash with large amounts of water for at least 15 minutes, occasionally lifting upper and lower lids (HSFS, 1989). The best way is using medical oil (olive, mineral) (MSDS, 1992).
- (6) Breathing
  - Remove the person from exposure.

- Begin rescue breathing.
  - Transfer promptly to a local hospital.
- (7) Do not eat, drink or smoke in the lab.

## CHAPTER 4

### REMEDIATION TECHNOLOGIES FOR PCBs CONTAMINATED SOIL

#### 4.1 Introduction

Polychlorinated biphenyls (PCBs) have been in the forefront of public and scientific concern for over 20 years, because of their persistence in nature. Of the roughly 1.25 billion lb of PCBs introduced into commerce in the US. since 1929. Only approximately 55 million lb have been destroyed by incineration or by degradation in the environment. 290 million lb are under varying degrees of control in landfills and dumps and 150 million lb are free in the environment. 750 million lb of PCBs are still apparently in service. It is estimated of the quantities of PCBs currently in the environment; i.e., PCBs in soil is estimated 12.8 million lb (Lauber, 1986).

Management of PCBs under the Toxic Substances Control Act (TSCA) since promulgation of the first regulations in 1978 has cost industry and government over \$1 billion. Since the first PCB incineration permit was granted by the US. EPA in 1979, PCBs have also been one of the most expensive chemicals to dispose of commercially. This chapter looks at the state of PCB remediation technology, reviewing the past and present technology development efforts and relating these technologies to the industry's remediated needs in the coming years (Woodyard, 1990).

#### 4.2 Legal Aspects in PCBs Remediation

TSCA regulations stipulate landfill and incineration as the acceptable options for PCB disposal, and include design criteria and destruction targets that are more stringent than their counterparts for other hazardous wastes under the Resource Conservation Recovery Act (RCRA). Commercial incineration and landfill capacity has been installed and operated for many years (Woodyard, 1990). The land disposal option is foreclosed for

liquid PCB wastes containing at least 50 but less than 500 ppm PCBs. The land disposal restrictions specify that these wastes must be destroyed in an incinerator or a high-efficiency boiler meeting the TSCA standards. For PCB concentrations greater than equal to 500 ppm PCBs, the wastes must be incinerated. Although an exemption from the land disposal prohibitions is available for wastes containing 50 to 500 ppm PCBs, it must be shown that the wastes will not migrate from the land disposal unit for as long as the waste remains hazardous ( McLoy, 1989).

One of the major driving forces for new technology development is associated with the relatively stringent standards associated with PCBs in soils and surfaces while EPA published its PCB spill cleanup policy in 1987 establishing federal PCB cleanup standards (10 ppm (non-restricted access) / 25 ppm (restricted access) in soil, 0.1/1.0  $\mu\text{g}/\text{cm}^2$  on surfaces), regional EPA and state policies have in some cases been more stringent. Soil treatment technologies have encountered greater difficulty in meeting these regional standards on routine cleanups (Woodyard, 1990).

On-site treatment and destruction technology is still subjected to significant research for those situations where off-site disposal presents an unacceptable liability for the generator, and where the scope of cleanup is considered too small to justify large - scale thermal treatment (less than 1000 tons) (Woodyard, 1990).

### **4.3 Soil Remediation Technology**

PCB soil remediation technology can be described by the following four major aspects:

- Thermal treatment
- Chemical treatment
- Physical treatment
- Biological treatment

#### 4.3.1 Thermal Treatment

Most of thermal treatment effort has focused on large-scale transportable incineration intended for a wide variety of organic contaminants in soil. Such as: Incineration companies: Vesta; Inciaerex ENSCO (Energy System Company), Haz-Tech Westinghouse Envirite ENSCO etc., the scale of projects are from 50 tons to 100,000 tons. Most of the systems involve integrated rotary kiln/afterburner technology which has been proven to be the most versatile for multi-waste sites. (Woodyard, 1990). Rotary Kilns provide a number of functions necessary for incineration, they provide for the conveyance and mixing of solids, provide a mechanism for heat exchange, serve as host vessel for chemical reactions, and provide a means for conducting the gases for further processing (Freeman, 1988). However most of these system suffer from a significant economy of scale and are generally thought to cost-effective only for sites containing a minimum of 5,000 tons of contaminated soil (Woodyard, 1990).

The demand for smaller capacity units has been filled in part by thermal separation systems, which remove the PCB from soil for destruction in an afterburner. Technology options include direct and indirect heating, and in most cases have the potential economic advantage of producing thermally treated soil rather than ash. Most thermal separation technologies have therefore seen PCB-related activity only at superfund sites or as part of alternative technology demonstrations for EPA. (Woodyard, 1990). For example: For about two years, burning PCB wastes at St. Lawrence Cement Co. 10,000 ppm of PCBs wastes were burned successfully and completely without any adverse environmental effects or chemical accidents. (Lauber, 1986).

US. EPAs Office and Research and Development has developed a mobile incineration system (thermal detorcification) for field use to destroy the long-lived organic refractory substances collected from cleanup separations at spills or at uncontrolled hazardous waste sites and to eliminate the need for transportation and or landfilling such wastes. This system was designed to meet the requirements for PCB



incineration previously noted in the US. EPA 40 CFR 761 regulations namely a minimum 2 Sec. residue time at 1,200°C, with 3% excess oxygen and a combustion efficiency of at least 99.9% (Lauber, 1986).

#### 4.3.2 Chemical Treatment

Chemical treatment to remove or detoxify PCBs in soil has been the subject of research and demonstration in recent years, primarily due to the desirability of in site remedial options. Demonstration - scale systems have included solvent or detergent washing and detoxification with more conventional PCB dechlorination chemistry. One of the few systems to survive the technology review process to date is KPEG (Peterson, 1985) technology for soil. This system has been the subject of several field demonstrations, and is the technology of choice for several upcoming Superfund remedial projects.

Apart from the physical problems of removing PCB from soil, most soil treatment systems have suffered more from the problem mechanics of soil/liquid separation and hazard classification of the final residue. Only further demonstration on a field production scale will determine whether the soil residue is suitable for replacement at the site, and whether waste water and other waste treatment problems relating to these systems can be remedied in a cost-effective manner (Woodyard, 1990).

#### 4.3.3 Physical Treatment

Physical separation techniques for *in situ* treatment have received significant attention in recent years, due in part to the growing number of sites where PCB- contaminated soil removal is infeasible due to buildings and other obstructions. *In situ* volatilization (ISV) and *in situ* vitrification techniques have both been considered for PCB removal of unsaturated soil. ISV systems in particular have become common for VOC removal from soil, and in some cases have collected PCB as a byproduct. Because of the low ambient vapor pressure of PCB, however, use of ISV systems for PCB removal will require

enhancement in order to achieve the current soil cleanup standards for most sites (Woodyard, 1990). In Situ Vitrification destroys PCBs in contaminated soils without excavation and is particularly attractive for small spills ( cubic inches to a few cubic yards). In Situ Vitrification was developed by Battelle as a technique for immobilizing low-level radioactive waste (McLearn, 1988). Enhancements might include localized vitrification itself, steam injection, or radio frequency heating. Steam injection technology has been increased activity for removal of semi-volatile organic compounds from soil, and at least one patent for steam injection to remove PCBs from soil is pending (Woodyard, 1990).

#### **4.3.4 Biological Treatment**

Biological treatment of PCB continues to be reviewed as a possible complement to other technologies, and is being considered as a long-term "polishing" step for several major cleanups where contamination levels are relatively low. The surface soil layer of well-filled crop land is largely aerobic. Scientists believe PCBs can be biodegraded under aerobic and anoerobic conditions (Gan, 1994). Environmental factors which will effect remediation effects include: oxygen and nutrient availability; soil moisture content; the pH of the soil, groundwater and hazardous waste; soil structure and organic content; temperature; solubility of the pollutants; concentration of toxic compounds and concentration of contaminant -degrading microbes. All of these factors should be assessed during treatability studies, and subsequently controlled during the bioremediation process (Roges, 1993).

## CHAPTER 5

### MW ENERGY-- FIXED AND A VARIABLE FREQUENCY

The frequency range extending from 300 MHz up 300 GHz is generally known as microwaves, which thus characterize signals having between 300 million and 300 billion periods per second (Gardiol, 1984), usually household MW-ovens operate at 2450 MHz. MW energy is composed of an electric field and a magnetic field which remain perpendicular to each other and to the direction of propagation within the waveguide. Microwaves are a nonionizing form of radiation which produces effects like reflection, diffraction and adsorption, thus interacting with the load. Microwave radiation penetrates deeply in certain materials, but not in others (metals, conductors) . Within the material itself, the electromagnetic energy is transformed into heat by means of several complex conversion mechanisms such as dipole rotation and stretching of large molecules, interface polarization and ionic conduction. Water is an example of the dipole material. It is a microwave absorption material in the liquid state since the dipole rotates at the rate that the applied field changes. However, water vapor or ice can not absorb microwave energy because the dipole rotates too fast in the gas phase to change its orientation with the changing the field; the rotation in the solid phase is too slow. When the material contains liquid water , It will absorb MW energy (Gu, 1990).

Materials that can be heated by microwaves are generally classed as lossy dielectrics. These exhibit conductivity as well as permittivity. Microwaves can penetrate into such materials, and the ohmic losses that occur in the equivalent conductance are dissipated as heat. The term *equivalent conductance* is used because it is made up of normal conductive effects, that is, free electron conduction, plus rotational and vibrational losses in molecules. The power density is given by

$$P_D = \sigma |E_i|^2 \quad \text{W/m}^2 \quad (5.1)$$

Where  $\sigma$  is the equivalent conductivity in S/m, and  $E_i$  is the internal electric field in V/m. The conductivity tends to increase with frequency for most lossy dielectrics, and a more useful parameter, termed the *loss tangent*, is used. The loss tangent is relatively independent of frequency for many materials and is defined as

$$\tan \delta = \sigma / \omega \epsilon'_r \epsilon_0 \quad (5.2)$$

Here,  $\omega$  is the angular frequency in rad/s of the microwave,  $\epsilon'_r$  is the relative permittivity of the dielectric (the dielectric constant), and  $\epsilon_0 = 8.854 \text{ pF/m}$  is the permittivity of free space. Substituting Eq. (5.2) in Eq. (5.1) gives the basic heating as

$$P_D = \omega \epsilon'_r \epsilon_0 \tan \delta |E_i|^2 \quad \text{W/m}^2 \quad (5.3)$$

It must be kept in mind that  $E_i$  is the internal electric field, and its relationship to the external field is complicated. The internal field will not necessarily be uniform, and local "hot spots" can be generated.

Data on dielectric materials are usually presented in the form of complex permittivity. Thus the complex relative permittivity (i.e., dielectric constant) is written as

$$\epsilon_r = \epsilon'_r - j\epsilon''_r \quad (5.4)$$

In any case,  $\epsilon'_r$  is the relative permittivity and  $\epsilon''_r$  is the loss factor. This in turn is given by

$$\epsilon''_r = \sigma / \omega \epsilon_0 \quad (5.5)$$

Thus the loss tangent can be written as

$$\tan \delta = \epsilon''_r / \epsilon'_r \quad (5.6)$$

To the extent that the loss tangent is constant, the power density is seen to be proportional to frequency, which is one reason for using high frequencies. Unfortunately, high-power microwave sources in the higher-frequency bands are not readily available, and this is one limitation at present on the use of higher frequencies.

A measure of the penetration depth of microwaves is the depth at which the fields are reduced by a factor of  $1/e$ . This, termed the *penetration depth*, is given by :

$$D = \frac{0.225\lambda}{\sqrt{\epsilon_r(\sqrt{1 + \tan^2 \delta} - 1)}} \quad (5.7)$$

This tends to suggest that greater penetration is obtained at lower frequencies, but to offset this, the magnitude of the internal field tends to decrease as the frequency is lowered.

Heat is generated in the load in an uneven manner, due to the resonant mode i.e.: When an electromagnetic wave impinges on a material sample, it is preferentially absorbed at particular frequencies, which are the resonant frequencies of material. The resonances observed at microwaves depend on the molecular composition of material (Gardiol, 1984). Areas of high intensity electric fields occur at different locations in the cavity and the load. This is due to the building of standing wave patterns, reflection of incoming frequencies on the sides of the cavity and interference patterns.

For a single wave propagating in a waveguide, the time average intensity of the electric and magnetic field does not vary along the direction of propagation. However, if one wave propagates in one direction and a second wave propagates in the opposite direction, the two waves interfere to produce a time average field intensity varies along the direction propagation. This field intensity variation is stationary in space and hence is referred to as a standing wave pattern. These standing waves pattern alternates with time at the microwave frequency. Standing waves are of particular with time at the microwave

frequency. Standing waves of particular interest in microwave heating systems since a material exposed to a standing wave field is not uniformly heated. This experiment employs SHARP Carousel II convection microwave oven (serial No. 02450 ; 700W) for the mapping of the intensity of the electromagnetic field within the cavity at fixed frequency.

The Variable Frequency Microwave Furnace (VFMF), which makes use of a high-power, broadband amplifier known as a traveling wave tube (TWT) , is capable of sweeping a range of frequencies of up to a octave in bandwidth. In each of the furnace cavity's resonant modes, the areas of high intensity electric field occur at different locations in the load. Continuous sweeping through several modes within a period of a few milliseconds results in time-averaged uniformity of heating throughout the load. This chapter reports on the use of 2.40 to 7.49 GHz VFMF (Lambda Technologies, model T-4001) to achieve significantly enhanced uniformity of heating over areas of greater than  $588 \text{ cm}^2$  - in a standard microwave oven cavity. Relative power density in VFMF has been characterized under both fixed and swept-frequency conditions. Mapping the field strength with and without load shows a different electromagnetic field distribution. The results clearly illustrate the significant advantage of using variable frequency heating techniques (Johnson, 1993).

## CHAPTER 6

### MAPPING THE ELECTROMAGNETIC FIELD DISTRIBUTION IN A FIXED FREQUENCY MICROWAVE FURNACE

#### 6.1 The Methods for Mapping Field Distribution Within a MW Cavity

There are several methods to determine the field distribution:

- (1) Place a certain numbers of evacuated vessel (neon tubes, light bulbs) in the MW cavity , when they are exposed to MW field for a certain time, they will emit light due to discharge.
- (2) A large number of small vessels are filled with water and inserted into the cavity (if necessary at several heights). After exposure to MW energy, the temperature should be measured simultaneously in all vessels, and the field distribution should be determined via the heating rule.
- (3) Instead of water, solid agar can be used (similar to gelatin). The weight loss due to drying can be used as a measurement for the strength of the field.
- (4) Cobalt Chloride ( $\text{CoCl}_2$ ) solution in water is sprayed on paper and the moist paper is exposed to the MW field. Where the field is strong , the paper will dry first,  $\text{CoCl}_2$  will turn blue ( where it is not complexed with water molecules). Unfortunately the picture is not stable.
- (5) Measurement with liquid crystals. (Grünwald, 1981)
- (6) The new method to determine the variable frequency MW field distribution is by using thermal paper and Teledeltos paper and styrofoam blocks (Johnson, 1993)

To study the heating distribution inside the oven, the following materials were used: styrofoam blocks , thermal paper, carbon paper, and a water load. The styrofoam blocks have a relatively low dielectric constant approximately equal to that of free space and a low loss tangent so that they are not heated by microwave power (Espinosa, 1993).

The thermal paper (Fax paper) doesn't appreciably absorb microwave energy (Johnson, 1993). However it will change color from white to black if brought into contact with a material that is heated in a MW field .

The carbon paper is coated with a thin film of carbon, which readily absorbs microwave energy, and Teledeltos paper is also heated in a MW field.

The mapping method designed for the field distribution is easy to handle and has a simple operating procedure. The mapping tells clearly where the field is strong, however , only high and low fields can be observed (black and white color on the thermal paper), no intermediate field strengths. It is employed to assess the effects of changing load characteristics .

Figure 6.1 shows the MW furnace dimension and thermal paper position used in the mapping.

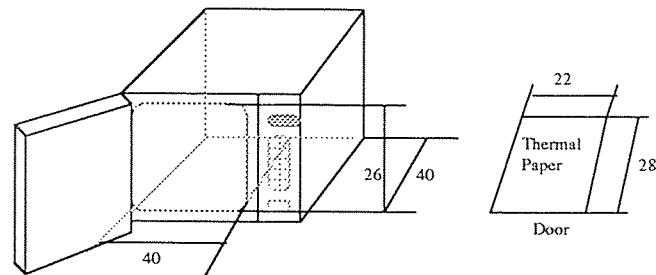

**Figure 6.1** Illustration of MW cavity and load position

The thermal paper with the styrofoam block was horizontally inserted into the center at the bottom of MW cavity, which is 9 cm from the left side and 6 cm from the front side.



## 6.2 The Field Distribution Mapping Method

The general procedure: MW furnace was warmed up for 5 min. using 500 ml water at the beginning of every batch of experiments. The color changing of the thermal paper (from white to black ) indicates that this area was heated . The areas that are first heated and show this color change are the regions that have a strong MW field; where areas that remain white have a low intensity field.

## 6.3 Result and Conclusions

### Test 1

#### Method 1

A thermal paper of the size 21x 28" is placed between two Styrofoam blocks,(position see Figure 6.2) and exposed to MW energy for 20 seconds. Figure A.1 shows the result.

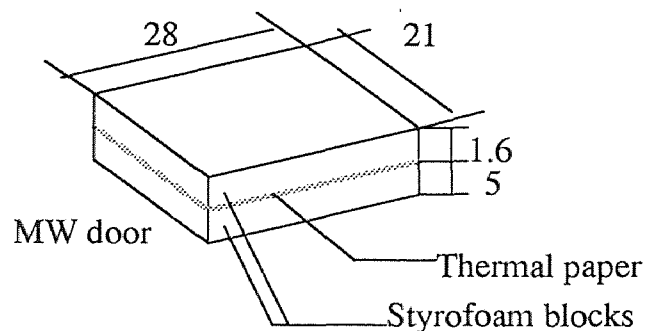

**Figure 6.2** Illustration of test approach

#### Method 2

A carbon paper is placed between two thermal papers which are "sandwich" between two styrofoam blocks. Figure A. 2 in shows the result of MW exposure.

Describe pattern: they are very similar , except Figure A.1. has more isolated spots of dark color near the areas with respect to the waveguide opening.

### Conclusion:

The field distribution in the horizontal area (2" above floor ) is not uniform. The thermal paper used in combination with a carbon paper show larger black area than only the thermal paper during the same heating time. Generally, these two methods show the same power distribution.

Method 1 is chosen for following test, because it is easy to operate .

### Test 2

(1) Two layers of thermal paper and styrofoam blocks.

Two thermal papers are separated by styrofoam blocks and sandwiched (Figure 6.3), and exposed to MW energy for 20 seconds. Figure A.3.1 and A.3.2 show the result: the top paper has a little weak black area, but the bottom paper remains like Figure 1 in Appendix A .

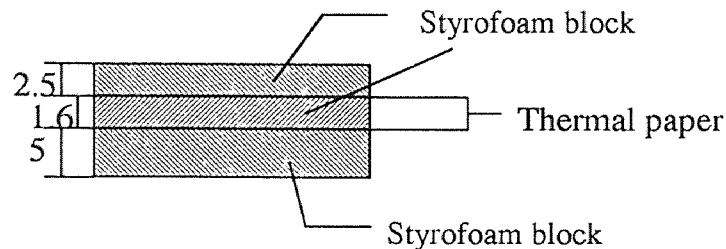

**Figure 6.3** Cross section of two layers of thermal paper

(2) Three layers of thermal paper and styrofoam blocks

Three thermal papers are separated by styrofoam blocks (Figure 6.4). After 20 seconds exposure the result is shown in Figure A.4.1 and Figure A.4.2 in Appendix A. The top paper has one small black area, the middle paper show very weak black area which look like Figure A.3 in, the bottom paper has identical black area with Figure A.1

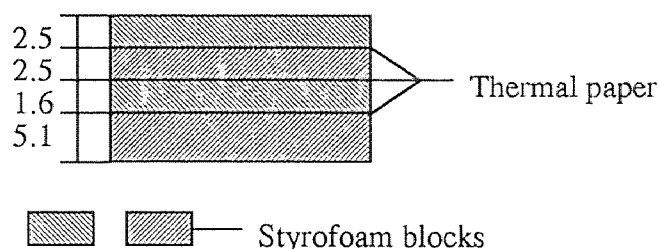

**Figure 6.4** Cross section of three layers of thermal paper

### Conclusion:

The MW power distribution is spatially not uniform in the cavity ( three dimensions). The field intensity is much stronger in the bottom layer. The field intensity in the top layer is little larger than in the middle layer.

### Test 3

One layer of thermal paper plus water load plus two styrofoam blocks .

Four different volumes of water are separately placed in the center of the testing area on the top of styrofoam blocks with thermal paper and exposed for 3 min. Water temperature is measured with a thermocouple probe before and after exposure . Table 6.1. and Figure A.5.1, A.5.2 , A.5.3 and A.5.4 Show the results.

**Table 6.1** The Temperature of the Load

Load ( water)	150 ml	300 ml	400 ml	500 ml
Initial temperature °C	25.9	26.1	26.6	26.1
Final temperature °C	99.0	93.1	76.2	77.8

### Conclusions:

The field intensity in the surrounding field is reduced as the volume of water is increased, The mapping of field distribution is totally different from the distribution where no water load was used (Figure A.1). A load disturbs the field distribution and may "channel" the MW energy into the load, where it is absorbed.

### Test 4

Place a beaker with 500 ml water in three different position (the beaker is on the top surface of the styrofoam blocks, see Figure 6.4). Exposure to MW for 3 min. Table 6.2 and Figure A.6.1, A.6.2 and A.6.3 show the results.

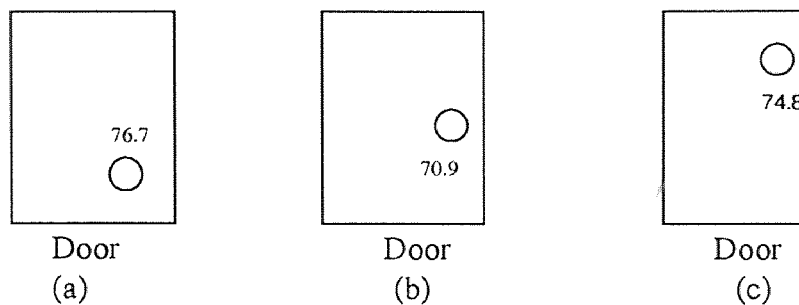

**Figure 6.4** Illustration of one beaker position (°C)

**Table 6.2** The Water Temperature at Three Loaded Position (1x 500 ml )

Load water position	( a )	( b )	( c )
Initial temperature °C	24.7	25.4	24.7
Final temperature °C	76.7	70.9	74.8

### Conclusion:

The field intensity and therefore the heating rule varies with the load position.

### Test 5

Place 3 beakers with 150 ml water each in 3 ways, Exposure time :5 min. (see Figure 6.5).

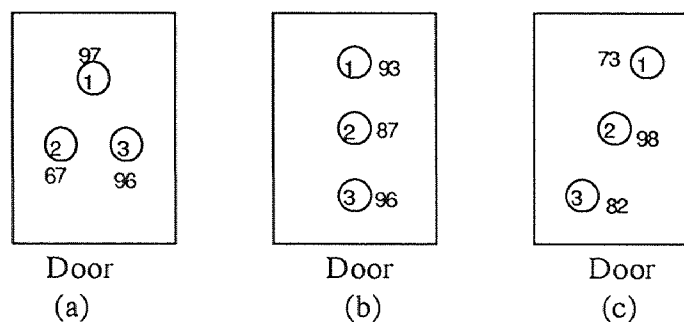

**Figure 6.5** Illustration of three beaker position (°C)

After exposure, the results (Figure A.7.1, A.7.2 and A.7.3) show that the black areas are very weak. The temperature measurement see Table 6.3.

**Table 6.3** Temperature Measurement of the Loaded Position (with Three Beaker of Water)

Loaded position	( a )			( b )			( c )		
	1	2	3	1	2	3	1	2	3
Initial temperature °C	24.1	24.1	23.8	23.7	24.2	24.9	24.7	24.6	23.9
Final temperature °C	97.4	67.1	96	93.8	87.7	96.7	73.7	98.0	82.5

### Conclusion:

The field intensity is reduced as the load is placed in the cavity separately. The field intensity in the surrounding field varies with the varying position of the load.

### Test 6

Use the same volume of water (500 ml ) and split it up : 1×500 ml; 2×250 ml (2 beaker with 250 ml water each); 5×100 ml (5 beaker with 100 ml water each).The loaded position is shown in Figure 6.7 and mestured temperature data is listed in Table 6.4. After exposure for 7 min. , Figure A. 8.1, A.8.2 and A.8.3 show the results: The color changing of load with 2×250 ml and 5×100 ml on the thermal paper can not be seen.

### Conclusion:

The field intensity in the surrounding field will decrease as the load is divided .

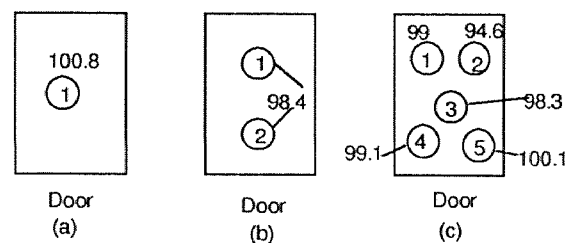

**Figure 6.7** Illustration of load position (°C)

**Table 6.4** Temperature Measurement of the Loaded Position (500ml Water)

Loaded position	(a)	(b)	(c)				
			1	2	3	4	5
Initial temperature °C	24.3	22.2	22.2				
Final temperature °C	100.8	98.4	99	94.6	98.3	99.1	100.1

## CHAPTER 7

### MAPPING THE ELECTROMAGNETIC FIELD DISTRIBUTION FREQUENCY IN A VARIABLE MICROWAVE POWER

#### 7.1 Microwave Apparatus

The model T-4001 Variable Frequency Microwave Furnace (VFMF), shown in Figure 7, is sold by Lambda Technologies, INC. under license from ORNL. The technology behind the VFMF represents a state of the art microwave processing system for delivering an unprecedented level of uniformity of energy distribution into a microwave cavity. By providing a user with the ability to vary both the amplitude and frequency of the microwave power being used, the VFMF expands the parameter space in which processes may be optimized. This air atmosphere furnace provides up to 200 Watts of microwave power (100 Watts minimum) over the 2.40 to 7.5 GHz frequency range - with programmable heating cycles. The furnace can be operated in fixed- or swept - frequency mode, and the power level into the cavity is completely adjustable. Digital display of forward power, reflected power, and frequency are provided. Temperature control and display is provided with an OMEGA TM CN76000 Temperature Process Controller. The furnace cavity's internal dimensions are 33 cm inches wide by 20 cm tall by 33 cm deep. All doors and panels are interlocked to prevent application of microwave energy when the cavity is ajar or application of high voltage to the microwave components when the panels are removed. The unit is available with or without remote computer control (Johnson, 1993).

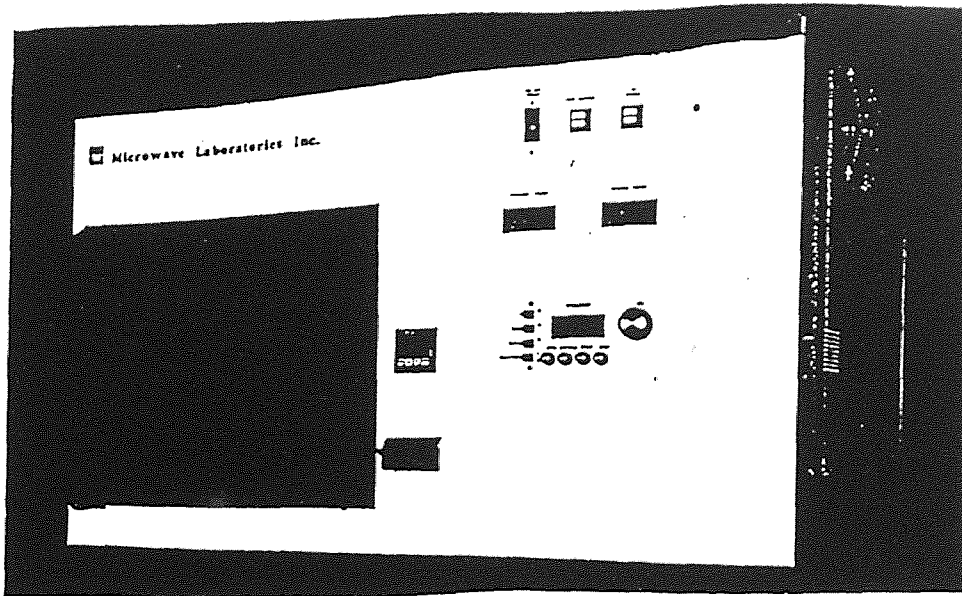

Figure 7.1 The Model T-4001 Variable Frequency Microwave Furnace

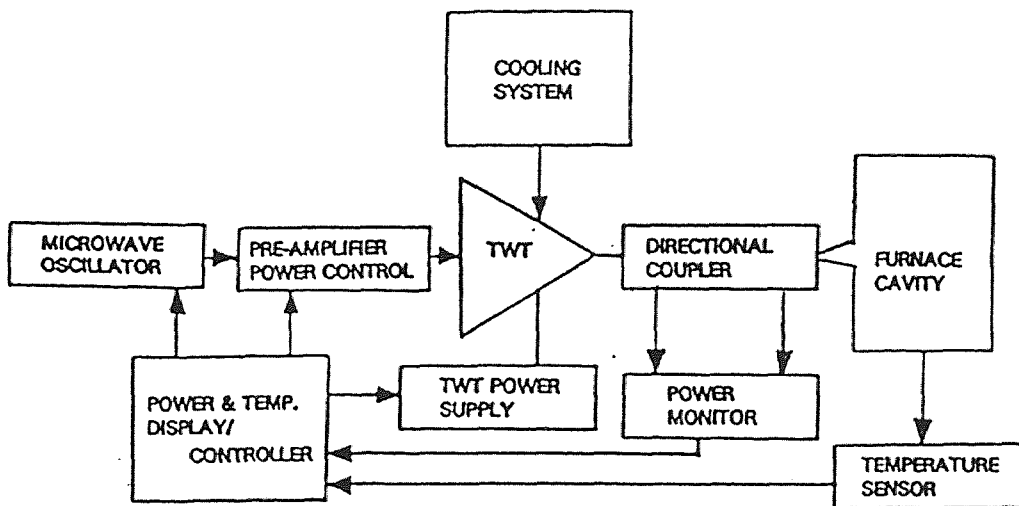

Figure 7.2 Block Diagram of the Variable Frequency Microwave Furnace



As illustrated in the block diagram of the VFMF in Figure 7.2, a broadband microwave amplifier known as a traveling wave tube (TWT) is at the heart of the microwave system. The particular TWT used in the T-4001 VFMF is the T-1095, which has 100 Watts minimum of output power over the 2.4 to 7.5 GHz frequency range at a minimum gain of 40 dB. This TWT is constructed using a brazed helix circuit technology, which has superior thermal conduction characteristics that enable the TWT to more efficiently dissipate the high levels (up to 100 %) of reflected power often encountered in processing applications without damage (Johnson, 1993).

## 7.2 The Power Distribution Mapping Method

The approach followed to study the uniformity of heating inside the VFMF is the same as described in Chapter 6. Instead of a carbon paper, Teledeltos paper was used in this experiment. The placement of the thermal paper, teledeltos paper and styrofoams is shown in Figure 7.3.

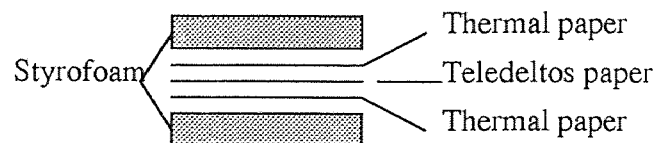

**Figure 7.3** Illustration of test approach

This method was developed to provide a graphic map of power distribution in the oven cavity that could be obtained quickly and with modest power levels.

Teledeltos paper readily absorbs microwave energy. Its surface resistivity is approximately 377 Ohms per square--i.e. it closely approximates free space. It can be used for several times. The Teledeltos paper was placed with its coated side in contact with the thermal FAX paper and tightly compressed between layers of styrofoam.

### 7.3 Test, Results and Conclusions

#### Test 1

Measurements under medium power (ca. 100 W) and continuous wave frequency (cw) is 2.45 GHz which is identical to the fixed frequency furnace.

(1) Parameters set are shown in Table 7.1.

**Table 7.1** Records of Parameters in cw= 2.45 GHz (= fixed Frequency)

Time of MW irradiation	40 seconds	30 seconds	25 seconds
forward power	114--117	112--115	114--115
Reflected power	45--46	29--40	40--41
Results	Figure B.1	Figure B.2	Figure B.3

#### Conclusion:

The heating areas were reduced from time 40 sec. to 25 sec. The size of heating area is depend on the exposure time.

(2) Load (100 ml water) in the three position on the top of the surface of styrofoam blocks ( Figure 7.4), exposure to MW for 25 seconds. The parameters set were shown in Table 7.2.

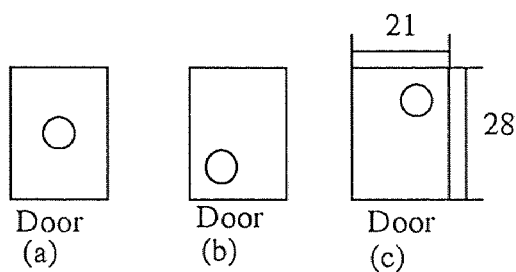

**Figure 7.4** Illustration of load position

**Table 7. 2** Records of Parameters

Load position *	(a)	(b)	(c)
Forward power	107--108	108--111	109--112
Reflected power	1-2	24--25	19--20
Results	Figure b.4	Figure B.5	Figure B.6

\*Note: See Figure 7.4

**Conclusion:**

The heating areas of the surrounding field varied with the load position, as showed with previous fixed frequency experiments.

**Test 2**

Measurement using the full frequency range (2.4 to 7.5 GHz), medium power (ca. 100 W) and sweep time is 0.1 sec. Exposure to MW for 40 seconds. The parameters are shown in Table 7.3.

**Table 7.3** Records of Parameters in the Full Frequency Range (sw=0.1 second)

Load position *	No load	(a)	(b)	(c)
Forward power	93--110	92--107	92--114	90--114
reflected power	6--25	3--20	6--16	7--19
Results	Figure B.7	Figure B.8	Figure B.9	Figure B.10

\* Note: See Figure 7. 4

**Conclusion:**

The results of swept- frequency runs show enhanced uniformity of the heating. The load can vary of the field distribution. The uniformity of heating under sw=0.1second, in the full frequency range was better than that under cw=2.45 GHz .

**Test 3**

Measurement under using 1 GHz frequency range, i.e. 6.5--7.5 GHz, 5.5--6.5 GHz, 4.5--5.5 GHz and sw=0.1 second (no load). The parameters are shown in Table 7.4.

**Conclusion:**

One GHz bandwidth in very short time resulted in a field distribution similar to that using a single frequency. Obviously the bandwidth (range of frequencies used) is very important for the field distribution.

**Table 7.4** Records of Parameters in 1 GHz Range

Frequency range GHz	4.5--5.5	5.5--6.5	6.5--7.5
Time of irradiation (second)	40	40	40
Forward power	81--100	71--89	44--91
Reflected power	4--7	1-12	5--7
Results	Figure B.11	Figure B.12	Figure B.13

**Test 4**

Measurement under two GHz bandwidth , i.e. 4.5--6.5 GHz, 5.5--7.5 GHz and sw=0.1 sec. within 1 minute (no load). The parameters are shown in Table 7.5.

**Table 7.5** Records of Parameters in Two GHz Range

Two GHz bandwidth	4.5--6.5	5.5--7.5
Forward power	69--72	74--100
reflected power	2--9	2--6
Results	Figure B.14	Figure B. 15

**Conclusion:**

The uniformity of heating area was similar at 4.5--6.5 GHz and 5.5--7.5 GHz within 1 minute and much more uniform than lower bandwidths.

**Test 5**

Measurement of field distribution using 1 GHz bandwidth (4.5--5.5 GHz and sw=0.1 second) with 100 ml water load in different positions. The parameters are shown in Table 7.6.

**Conclusion:**

1. The uniformity of heating areas using 1 GHz frequency range was reduced when the time of irradiation was decreased. Heating area can be changed by loaded position.
2. The VFMF power distribution is not uniform in the whole cavity,, the heating intensity was much stronger in the top layer than in the bottom layer in the cavity.

Table 7.6 Records of Parameters in 1 GHz with Different Positions 100 ml Load

Placement	No Load		Loaded position <sup>a</sup>			Different levels <sup>b</sup>
			(a)	(b)	(c)	
Time (second)	60	40	40	40	40	120
Forward power	101--107	99--107	107--115	106--107	109--116	93--104
Reflected power	7--8	7--9	5--11	4--6	7--8	0--1
Figure .	B.17	B.18	B.19	B.20	B.20	B.16

a--See Figure 7.4 for load and position

b--Two layers of Teledeltos paper at different levels without load.

### Summary of Conclusion

Sweeping a range of frequencies significantly increases the uniformity of the MW field distribution., the larger the bandwidth, the better / more uniform the field distribution. The heating intensity depend on the exposure time, the longer the exposure time, the stronger the heating intensity. The field distribution in the whole cavity is not uniform, the heating area in the higher levels of the cavity is stronger than in the bottom.

The field distribution varied with load position.

Sweeping over even a one GHz frequency range produces not a very uniform power density in the furnace cavity, similar to operation at fixed frequency (where the effects are more pronounced). The distribution is determined by the operating frequency and the bandwidth the load's dielectric constant and exposure time. These results indicate that variable frequency microwave sources can provide power for uniform processing of materials on an industrial scale. They also demonstrate the versatility of the VFMF as a tool for the development of microwave processing application ( Johnson, 1993 ).

In the following experiments, VFMF will be used to treat the contaminated soil sample.

## CHAPTER 8

### THE ANALYTICAL PROCEDURE OF SOIL SAMPLE

#### 8.1 Sample Preparation

The contaminated soil samples are prepared as follows:

The stock sample B was contaminated with pure 25 mg of PCB #65 or PCB #53 (Ultra Scientific 99+99%) to levels of Ca. 400 ppm (mass/ mass) in the following way:

- Weight the stock soil to Ca. 62.5g , record the exact weight and then transfer soil to a beaker.
- 1 ml of solvent ( hexane ) was used to dissolve pure PCB #65 (or PCB #53) for 5 hours. Hexane non-spectro manufactured by Baxter --Burdick & Jackson brand is a high purity solvent ( b.p 69°C; Lot number: BG066 & BD415 ) and is suitable for gas chromatography and pesticide residue analysis.
- Add PCB solution to the top of soil 1 ml at a time (using a 1000 ul pipette), mixing well by using stainless steel spoon after adding each a volume.
- Place the contaminated soil in the ventilation hood to evaporate the solvent over night before extraction experiments.

#### 8.2 MW Measurement

##### 8.2.1 Selection of Reaction Vessels

Of the many types of reaction vessels tried in using full spectrum Variable Frequency field ( 2.4 to 7.50 GHz ) the most appropriate vessels were identified as Coors high alumina crucible and DFC Ceramic crucible.

Coors AD-998 High-Alumina labware is made of 99.8 % - pure recrystallize aluminum oxide. It is highly resistant to chemical attack (Table 8.1).

**Table 8.1** Typical Physical Properties of Coors AD-998 Crucible

Maximum use temperature (no load)	1750°C
Thermal-Expansion Coefficient (25°-100°C)	$8.0 \times 10^{-6}/^{\circ}\text{C}$
Compressive strength	>300,000psi
Water absorption	none

DFC Ceramic crucibles, they were non-absorptive and have high chemical resistance.

Coors crucible was chosen to be used in this experiment, because the Coors crucible has enough space to put glass wool and glass beads on the top of soil.

### 8.2.2 MW Treatment Procedure

Transfer approximately 4g (record weight to the nearest 0.01 g) of sample to a Coors crucible (record the exact weight of sample), glass beads which separate the sample and glass wool were put on top of the soil, and the sample taped shut with scotch tape. A hole was pieced to allow the insertion of a fiberoptic temperature probe into the sample center. After warm-up of the Variable Microwave Furnace mode, the crucible (inserted in an isolating sand bath using a 4 cm high Coors crucible) was placed in the center of the cavity. The soil sample was Ca. 30 mm elevated from bottom. After all MW parameters have been set, the irradiation was started and automatic temperature measurement were recorded every 3 seconds (print out and computer file). After irradiation the temperature probe was removed and the crucible cooled to room temperature.

### 8.3 Extraction Procedure

After cool down the soil was transferred into a PP (poly propylene) jar, the PP jar was capped before proceeding with the next sample to avoid any cross contamination. 25 ml of hexane was added to the sample. Ultrasonic extraction method similar to EPA Method 355 and VirSonic 475 Cell Disrupter were employed in this experiment.

Ultrasonic extraction is an extraction method in which cavities, formed by sound pressure waves, collapse in the fluid; the collapse of the cavities causes shock waves which create maximum contact between the fluid and the soil sample.

The VirSonic 475's reliable solid state power supply is built for continuous duty, providing 20 KHz of high frequency electrical energy. This energy output is fully adjustable and displayed on a panel mounted indicator ( in % of wattage output ), enabling precise reproduction of experimental, parameters. This electrical energy is transmitted to the unit's converter, where it is transformed into mechanical vibrations by highly efficient piezoelectric transducers. These ultrasonic vibrations are intensified and focused into the sample by interchangeable titanium disrupter horns and microprobes (Source "Manual for the VirSonic 475 Cell Disrupter).

EPA method 3550 is a procedure for extracting non-volatile and semi-volatile organic compounds from solids such as soils, sludges, and wastes. The Ultrasonic extraction was performed for 4 minutes at a power setting 3.8 with a VirSonic 475 and vacuum filtration (Ceramic Buchner funnel, filter paper: whatman No. 41) followed. The final volume of the filtrate was noted, 1.0 ml was transferred into an amber septum vial ( From National Scientific, Target DP vials) by using V3-series pipettes (Adjustable tip ejector V200TE/V1000TE). The vials were labeled and kept at 4 °C until GC/MS analysis which usually followed within 24 hours.

#### **8.4 Analytical Procedure**

The extracts were adjusted to room temperature before injection. The injection volume was 1.0 ul using a Hamilton syringe with a changeable adopter.

After the GC/MS run, the total ion chromatogram (TIC) was further broken down to show the selected ion chromatogram (SIC) in the ion range of interest, which is indicative of the presence of the PCB congenes.



In this experiment, because the molecular equation is  $C_{12}H_6C_{14}$  for the PCB congeners used the molecular weight is 291.991 g/mole; the selective mass ranges are 287--297 amu. The GC/MS parameters: Tune file, Acquisition file and Integration Event file are shown in Figure 8.1, 8.2 and 8.3. A record of the results was generated for each injection. Data on the original injections (TIC, SIC, Integration etc.) is available upon request) For example the TIC and SIC spectra of PCB#65 was shown in the Figure 8.4.

### 8.5 Calibration Curve

At least five concentration levels of standard solution were prepared, the standard solution were prepared by adding 1000 ul hexane to 25 mg pure PCB#65 , the diluting of it to six levels : 0.25, 2.5, 25, 50, 100, and 250 ng/ul. Three injections per concentration were used for each point of the calibration curve. After the GC/MS runs and integration of SICs, the calibration curve will be generated using HP 59970 Chem Station. The same method was used for PCB#53 (See Figure 8.5 and Figure 8.6).

### 8.6 Quality Assurance and Quality Control

In the laboratory contamination can occur during sample handling at various stages of sample preparation and analysis. Contamination can occur from containers and reagents used in the laboratory or from the environment and laboratory air. Similar contamination sources are also present during the analytical procedure. So, blank samples must be run to assess and control contamination in measurements. A lot of blanks serve as this purpose. A *soil blank* is used in this analysis to check for the presence of impurities / other contaminants in the soil. Soil blank samples were run before and after a batch of treated soil samples.

*Instrument blank* is also done automatically by the GC/MS (tune program) before every batch of sample was analyzed. The purpose of tuning is to achieve the best mass

spectrometer sensitivity across the mass range consistent with peak shapes that enable mass measurement and possibly quantitation to the required degree of precision.

TUNE Version 3.1.1 7-Mar-88  
Mass spectrometer is off

MASS SPECTROMETER PARAMS FILE: DATA:JUNTU

Multiplier: 1400 Emission: ON  
amu Gain: 120 amu Offset: 58 Repeller: 10.2  
ion Focus: 4.0 ent Lens: 65 X-ray: 52.0  
mass gain: -1? mass offset: 16

ACQUISITION & DISPLAY PARAMS FILE: DATA:JUNTU

tune Mass1: 69.00 tune Mass2: 219.00 tune Mass3: 502.00  
misc Info: Perfluorotributylamine (PFTEA)  
Window: 5.00 Averages: 1 stepsize: 0.10  
Scale: 100 scale mode: Autoset mass3 Factor: 1.0  
scan range Low mass: 10.0 High mass: 800.  
Threshold: 500 samples (2\*10): 2

NORMALIZATION FACTORS FILE: DATA:JUNTU

m/Z	Target %	m/Z	Target %
50	1.5	69	100.0
131	55.0	219	55.0
414	4.0	502	4.0

MASS SPECTROMETER PARAMETER RAMP LIMITS

PARAMETER	MINIMUM	MAXIMUM	STEPSIZE
Repeller :	4.00	10.2	0.20
ion Focus :	0.0	204.	4.0
ent Lens :	0	255	5
X-ray :	0.0	204.	4.0
amu Gain :	0	255	1
amu Offset :	0	255	1
Multiplier :	0	3000	200

TEMPERATURE PROGRAM & HEATED ZONES

run time 15.00 equilibration time 0.50 Purge off time 6.00

level	initial tEmp	initial time	Rate (°C/Min)	Final tEmp	Final time	total time
1	80	1.00	30.0	150	5.00	6.00
2			60.0	275	0.00	10.42
3						
4						
5						
6						
7						
8						

	actual	Setpt	Limit		actual	Setpt	Limit
Oven (Standby)	126	80	100	Inj Port A	---	Off	250
Inj Port B	136	100	250	Transfer Line	227	230	300
Detector A	---	Off	250				

Figure 8.1 Tune File

GC SCAN ACQUISITION : 21 Sep 94 3:25 am DATA:PCB1.A

solvent delay 6.00 eV volts relative resulting voltage 1400

	start Time	Low mass	High mass	Scan threshold	a/d samples (2**N)	scans per second
1	0.00	50.0	450.0	1000	2	1.07
2	-----	50.0	550.0	1000	2	0.86
3	-----	50.0	550.0	1000	2	0.86

REAL TIME PLOT PARAMETERS

number of traces 1 initially ON time Window 10.0

Plot # 1 Total Ion Scale 3000000

Temperature Zones

Initial temperature : 80.00  
Initial time : 1.00  
Equilibration time : 0.50

	Set Points	Soft Limits	Status
Oven	80	300	On
Inj Port A	0	250	Off
Inj Port B	180	250	On
Transfer Line	280	300	On
Ion Source	0	250	On
Mass Analyzer	0	300	On
Detector A	0	250	Off
Detector B	0	0	On

Plot Parameters

Plotting Active : TRUE  
Plot Start Time : 6.00  
Number of plots : 1  
Time Window : 10.00

Display 1

Low mass : 10.00  
High mass : 800.00  
Scale : 3000000.00  
Plot type : Total Ion

Als control

Number of Sample Pumps : 1  
Number of Sample Washes : 1  
Number of A washes : 1  
Number of B washes : 1  
Pre-wash bottle : 1  
Post-wash bottle : 0  
Stroke : Full  
Viscosity : High  
Injector mode : On column  
Injection mode : MANUALLY

Miscellaneous

Description : PCBs IN HEXANE  
Operator : LLZ  
Date & time : 22 Feb 94 4:57 pm  
Inlet : GC  
Configuration file : DATA:JUNTUNE.U  
Acquisition mode : Scan

Figure 8.2 Acquisition Parameter File (Data: PCB1.A)

```

*** Integrator Events ***
Initial Peak Width      0.020
Initial Threshold      18
Initial Area Reject    1
          Shoulders OFF

0.000 Integ OFF
9.400 Integ ON
9.400 Area Sum ON
9.700 Integ OFF
9.700 Area Sum OFF

*** Integrator Events ***

Initial Peak Width      0.020
Initial Threshold      18
Initial Area Reject    1
          Shoulders OFF

0.000 Integ OFF
9.250 Integ ON
9.250 Area Sum ON
9.550 Integ OFF
9.550 Area Sum OFF

```

Figure 8.3 Integrator Event File

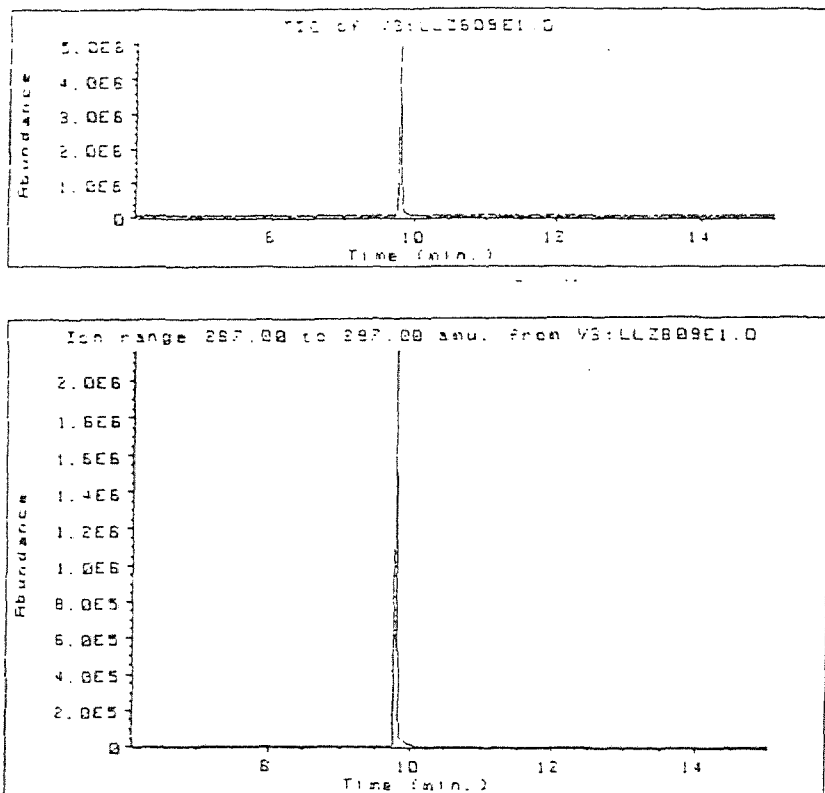

Figure 8.4 TIC and SIC Spectra of PCB#65

## \*\*\* Calibration Table \*\*\*

PCB#65 IN HEXANE 0.25 ng/ul TO 50 ng/ul LLZ 3 INJECTIONS,7/27

Last Update: 15 Aug 94 2:08 pm

Reference Peak Window: 5.00 % of Retention Time

Non-Reference Peak Window: 5.00 % of Retention Time

Sample Amount: 0.000 Uncalibrated Peak RF: 0.000 Multiplier: 1.000

Ret Time	Pk#	Signal Descr	Amt ng/ul	Lvl	[Heigh	Pk-Type
9.735	1	287.00- 297.00 amu	0.2500	1	309745	1
			2.500	2	1066666	
			25.00	3	4933551	
			50.00	4	12857168	

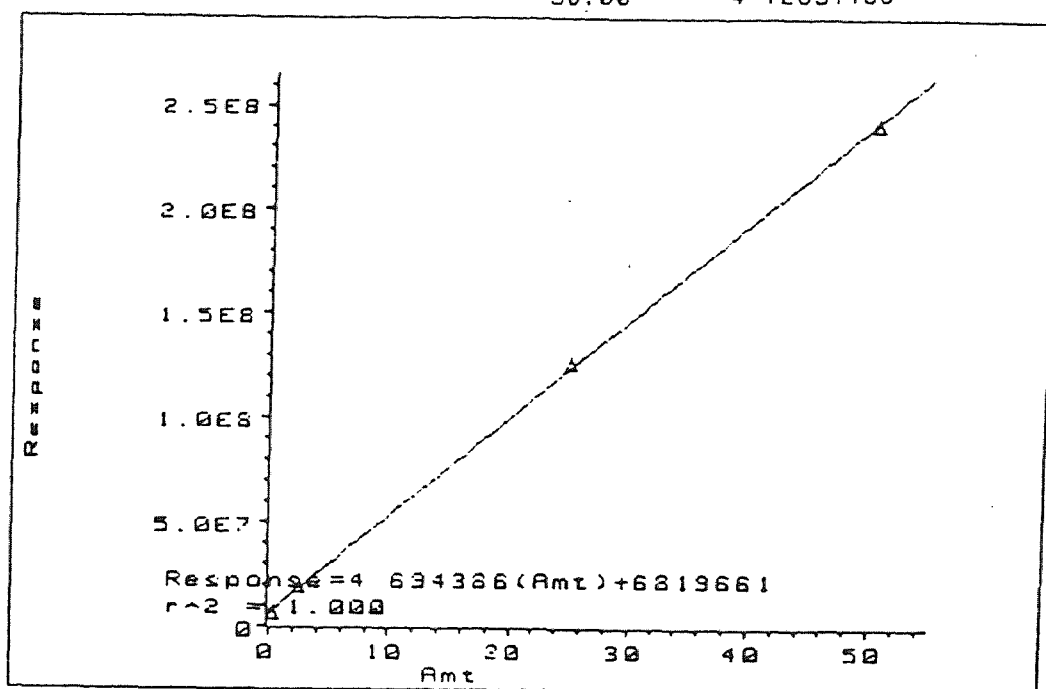

Figure 8.5 Calibration Curve for PCB#65

## \*\*\* Calibration Table \*\*\*

PCB#53 STD. IN HEXANE FROM 0.25 ng/ul TO 50 ng/ul

Last Update: 28 Sep 94 1:02 pm

Reference Peak Window: 5.00 % of Retention Time

Non-Reference Peak Window: 5.00 % of Retention Time

Sample Amount: 0.000 Uncalibrated Peak RF: 0.000 Multiplier: 1.000

Ret Time	Pk#	Signal Descr	Amt ng/ul	Lvl	[Area]	Pk-Type
9.552	1	287.00- 297.00 amu	0.2500	1	191671	1
			2.500	2	2610074	
			25.00	3	22198411	
			50.00	4	38946982	

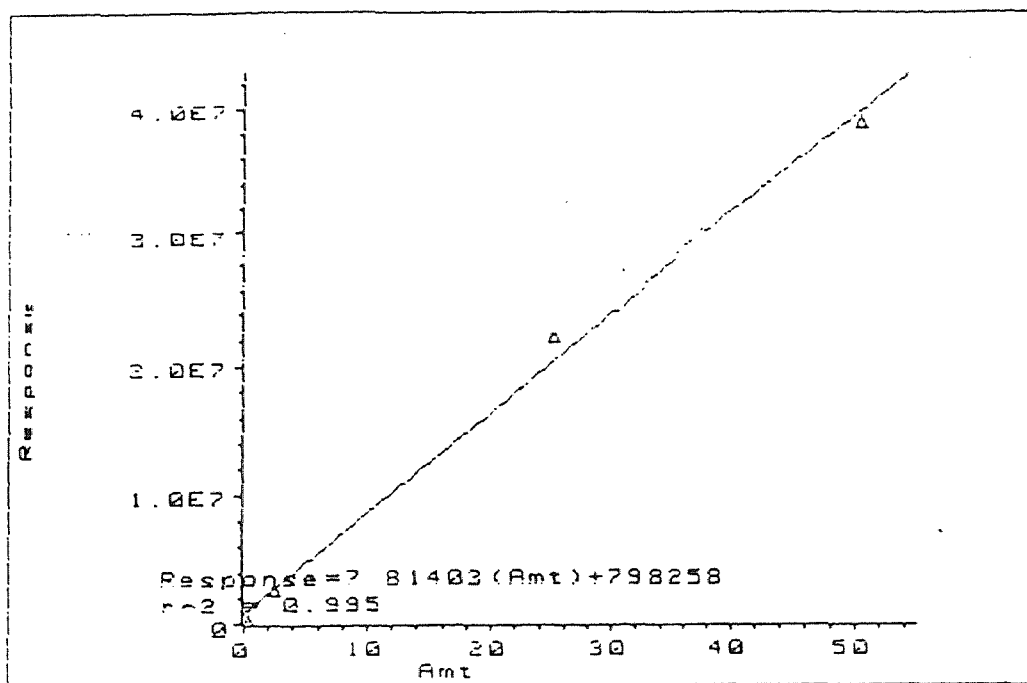

Figure 8.6 Calibration Curve for PCB#53

## CHAPTER 9

### GC/MS ANALYSIS

#### 9.1 Introduction to GC/MS

All instrumental methods are based on relatively well known and fairly simple principles of physics and chemistry. The methods, their principles and their characteristics are summarized in Table 9.1 (Karasek, 1988).

**Table 9.1** Instrumental Methods and Their Characteristics

Method	observed data	Sample components determined	Qualitative	Quantitative	sensitivity g
Infrared spectroscopy (IR)	Characteristic spectrum	1	Fair	Good	$10^{-3}$ - $10^{-6}$
Nuclear magnetic resonance (NMR)	Characteristic spectrum	1	Good	Good	$10^{-3}$
Gas chromatograph GC	Chromatogram of separated compounds	1-300	Poor	Good	$10^{-12}$
High performance liquid chromatograph (HPLC)	Chromatogram of separated compounds	1-300	Poor	Good	$10^{-9}$
Mass spectrometry	Characteristic mass spectrum	1-3	Good	Good	$10^{-12}$
Gas chromatography-mass spectrometry (GC/MS)	Chromatogram /mass spectra	1-300	Good	Good	$10^{-12}$



The combination of the gas chromatograph with the mass spectrometer has resulted in an instrument of considerable importance in the field of chemical analysis and detection. This technique is given the separating power of chromatography and the identifying power of mass spectrometry. It has been used for identification of hundreds of components that are present in natural and biological systems, for example, these procedures have permitted characterization of the odor and flavor components of foods, identification of water pollutants, medical diagnosis based on breath components, and studies of drug metabolites Figure 9.1 (Message, 1984) shows the principal element of a GC/MS system. A computer system is included in the diagram, as well as its interface with the instrument operator. It adds a new dimension and power to the analytical abilities of a GC/MS system. A GC/MS from Hewlett -Packard HP5890/5970 is employed in these experiment .

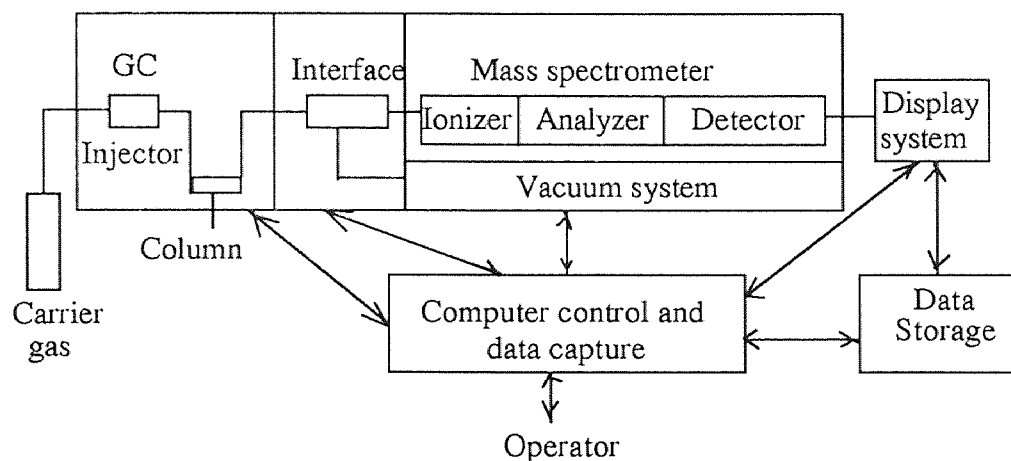

**Figure 9.1** Block diagram of GC/MS system

It is the purpose of the chromatographic column to separate out the components of what may be a complex chemical mixture. The stationary phase in a GC is usually a very viscous liquid with characteristics to retain special components (polar, nonpolar column etc.). This liquid coats the walls of the capillary column. A GC/MS uses gas-liquid chromatography. A typical GC/MS arrangement consists of a heated injector assembly

connected to a column mounted in a temperature controlled oven (Figure 9.2). In the injection port, the sample is vaporized and injected onto the head of a chromatographic column. Elution is brought about by the flow of an inert gaseous mobile phase of high pressure (Head pressure in these experiment was 9 Psi). This mobile phase is then brought into contact with an immiscible stationary phase, which is fixed in place in a column. The two phases are chosen so that the components of the sample distribute themselves between the mobile and stationary phase to varying degrees. Those components that are strongly retained by the stationary phase move only slowly compared to the flow of mobile phase. In contrast, components that are weakly held by the stationary phase will travel rapidly and reach detector in turn fast (separation of compounds over time = retention times).

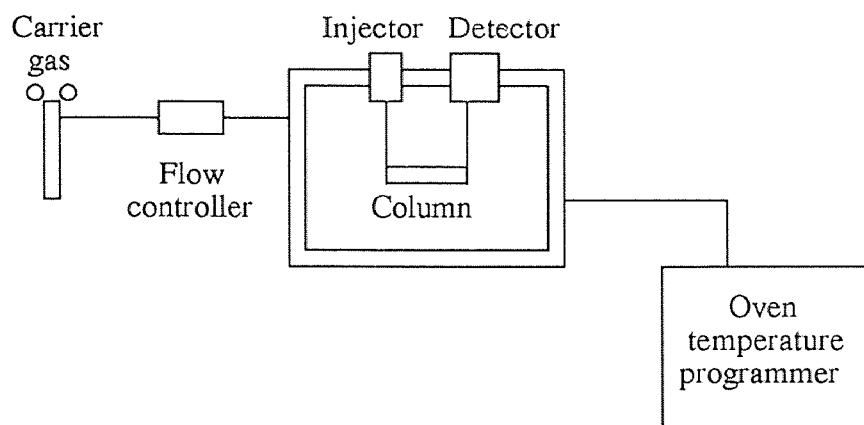

**Figure 9.2** Schematic diagram of GC

The GC 5890 can be operated splitless or with a split inlet. In these experiments, the HP5890 operated in a split Len mode. An HP-1 (PONA 12.0 m x 0.2 mm x 0.33) capillary column was installed to analysis of PCBs. The sample flows from the GC column into the MSD, where it enters the ion source. It is bombarded with 70 *ev* electrons causing molecules to ionize and then fragment. The bombardment of the electrons produces positive, negative and neutral ions of which only positively charged

ions are detected by the HP5970 B. The ions are propelled out of the source and are focused with several electromagnetic lenses into the quadrupole mass filter, which acts as a discriminating filter against all positively charged ions except those of a selected mass. It is based upon the resonance of applied radio frequency fields with resonance characteristic of an ion fragment with a specific mass. When resonance occurs, the ion can pass through the field and reach electron multiplier detector, while other ions are prevented to reach the detector. When the selected ion(s) hit the electron multiplier, a current is generated, the more ions that hit the detector, the more current is generated. The electronics in the MSD convert current into an analog voltage which is then converted into a digital signal. The ion abundance information is sent to the data system which is controlled by the HP 59770 Chem Station included the NBS library search system, which stores more than 30,000 mass spectra.

An essential element in good mass spectrometer performance is a high-quality vacuum system. The pressure requirement vary with instrument type and application, but  $10^{-5}$  torr is a typical maximum, and often lower pressure is necessary. Insufficient vacuum may lead to decreased sensitivity, arcing, excessive contamination of parts, and a short life expectancy of the electron multiplier.

## 9.2 Main Properties of GC/MS

### 9.2.1 Detection Limit

GC/MS is unique in its ability to quantify trace levels of specific organic compounds in the presence of hundreds of other substances, some of which are present in concentrations thousands of times higher than the analyte. The GC isolates the analyte from most of the other components in a mixture and MS provides selective and sensitive detection. To achieve low detection limits, the instrument can scan any mass range between 10 and 800 amu in 0.1 amu steps. Up to three mass range may be selected using time programming.

### 9.2.2 The Choice of Carrier Gas

The choice of carrier gas which serves as the mobile phase is very important. Nitrogen and helium are the best choice for GC/FID. Nitrogen, the usual gas chromatography carrier, has a much lower pumping speed. Unlike the lighter gases such as helium and hydrogen, it is not removed easily from the vacuum chamber by pumping system and would put greater constraints on the separator performance. Nitrogen also cools significantly when it expands into region of lower pressure, condensation of the sample could be a problem. Helium and hydrogen do not show this effect as much. Because nitrogen has a molecular weight of 28, one could not observe any mass below 28. The MS operates for 10-800 amu, with nitrogen as a carrier gas, one could only observe masses from 29-800 amu. Helium and hydrogen are below 10 amu and are both used as carrier gases in GC/MS system. Helium is the most common because of safety consideration. In the GCHP5890, the carrier gas is helium.

### 9.2.3 The GC Column

The GC column is the heart of a GC system. Without its separating power, the mass spectral data would be impossible to interpret. The degree of resolution required for adequate separation will depend on the complexity of the sample that has to be analyzed.

The GC columns most widely used fall into two distinct categories: packed and capillary columns. Packed columns do not possess the high efficiencies and separating capacities of capillary columns, but they do have higher capacities which simplifies sample introduction techniques and provides a larger quantity of sample component for introduction to the detector. Typical packed columns for analytical work are 2-5 m in length and have 2 mm ID. They use carrier gas flows of 20-50 ml/min. Capillary columns were developed by using fused silica capillary columns, these columns are made of pure SiO<sub>2</sub> and are extremely rugged when an external coating of polyimide polymer is applied. The technology of producing high quality columns of controlled internal diameter and

stationary film thickness has advanced considerably. Commercially available fused silica capillary columns with both polar and nonpolar stationary phases have a consistently high efficiency and give excellent analytical results. They are clearly the columns of choice for GC-MS application. These capillary columns permit the use of GC-MS interfaces that transmit the maximum amount of organic material to the mass spectrometer ion source (Karasek, 1988) Simple mixtures are best suited to packed columns, with relatively short analysis times. Complex mixtures usually require the higher resolution of capillary columns with correspondingly longer analysis times. The outstanding advantage of capillary column versus packed columns is that the choice of stationary phases which is very important for capillary columns becomes less of a problem because their efficiency is so high.

#### **9.2.4 Temperature Programming**

This temperature programming is used to improve separation and speed up analysis, especially for complex samples which contain many compounds having a wide range of boiling points, This technique is performed by changing the temperature of the GC column at a definite rate as the analysis proceeds. This causes components of the sample to elute at an earlier retention time than they would under isothermal conditions. High molecular weight components that have high retention times and broad peaks in isothermal GC analysis elute as rapidly providing sharp and narrow shaped peaks using temperature programming. A GC with a temperature program can show all components of a mixture with a wide range of compounds: all components can be eluted with good peak shape and in reasonable time. The GC is started at a low temperature that is effective for low-boiling compounds, then the oven temperature increased at a specific rate to a high final temperature, several temperature plateaus can be used to optimize the resolution (Karasek, 1988)..

In this experiment, GC/MS is employed to analyze the extracts of soil samples. In all cases it is important to have a knowledge of the sample and its preparation.

The data for every run is digitally stored, and can be manipulated in many ways to obtain other information. For example a spectrum of masses (Figure 9.3) detected at a specific time during the run can be shown. This spectrum (for instance at a peak in the TIC) can be compared to the 38,000 spectra stored in the NBS library files. The library search (Figure 9.4) gives the 10 best matches found, and the goodness of fit, compared to the spectrum from the TIC Figure 9.3 (Windegasse, 1988). For an example:

As one can see, the identification is not always clear. This is partly due to the fact, that the NBS library takes into account only the 10 best highest peaks in the spectrum and their relative abundances. Since identification was not the purpose of these experiments, we did not make efforts to come to a clearer understanding of the nature of the compounds. Following are the best matches for peaks 1 to 14 from Figure 9.3

- 1) 1,1'-Biphenyl, pentachloro-(9C1)
- 2) 1,1'-Biphenyl, pentachloro-(9C1)
- 3) 1,1'-Biphenyl, 2,2',4,4',6,6'-hexachloro
- 4) 1,1'-Biphenyl, 2,2',3,4,5,5'-hexachloro
- 5) 1,1'-Biphenyl, 2,2',3,4,5,5'-hexachloro
- 6) 1,1'-Biphenyl, 2,2',4,4',6,6'-hexachloro
- 7) 1,1'-Biphenyl, 2,2',3,4,5,5'-hexachloro
- 8) 1,1'-Biphenyl, 2,2', 3,4, 5,5'-hexachloro
- 9) 1,1'-Biphenyl, 2,2',3,3',5,5',6-heptachloro
- 10) 1,1'-Biphenyl, 2,2',3,3',5,5',6-heptachloro
- 11) 1,1'-Biphenyl, 2,2',3,3',5,5',6-heptachloro
- 12) 1,1'-Biphenyl, 2,2',3,3',5,5',6-heptachloro
- 13) 1,1'-Biphenyl, 2,2',3,3',4,5,6,6' octachloro
- 13) 1,1'-Biphenyl, 2,2',3,3',4,5,6,6' octachloro

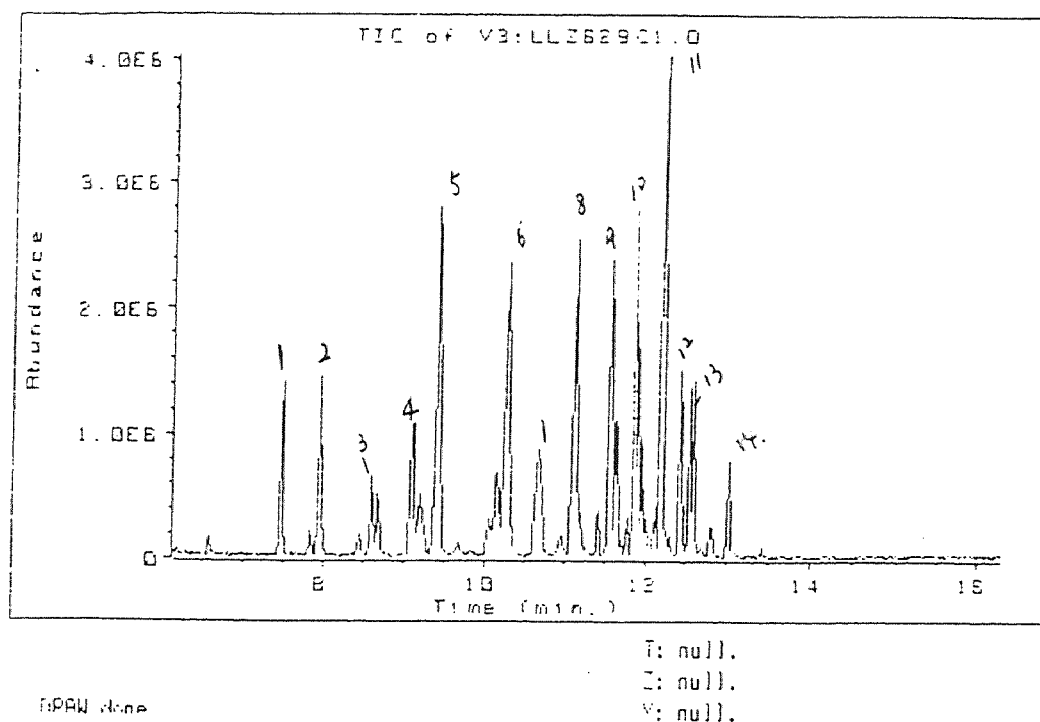

Figure 9.3 TIC spectrum of Aroclor 1260

LIBRARY SEARCH RESULTS

Average of 7.454 to 7.503 min. from V3:LLZ62901.0  
1000ng/ul Aroclor1260 IN HEXANE 6/27/94

Library file: NBS\_REVE.L

Library name: NBS MASS SPECTRAL DATABASE

	CAS #	Library Index #	Match Quality
1: 1,1'-Biphenyl, pentachloro- (90)	33429292	29027	9386
2: 1,1'-Biphenyl, 2,3',4,4',5-pentachloro-	31508006	29028	9356
3: 1,1'-Biphenyl, 2,2',4,4',5-pentachloro-	33280017	29032	9187
4: 1,1'-Biphenyl, 2,2',4,5,5'-pentachloro-	37580732	29030	9179
5: 1,1'-Biphenyl, 2,2',3,4',5'-pentachloro-	41464511	29035	9156
6: 1,1'-Biphenyl, 2,2',3,5,5'-pentachloro-	52865613	29037	9001
7: 1,1'-Biphenyl, 2,3,3',4',6-pentachloro-	33180039	29034	8989
8: 1,1'-Biphenyl, 2,3,3',4,4'-pentachloro-	12592144	29029	8877
9: 1,1'-Biphenyl, 2,2',3,3',6-pentachloro-	52863602	29036	8859
10: 1,1'-Biphenyl, 2,2',3,3',4-pentachloro-	52863624	29038	8825

Figure 9.5 Library search result for one peak in Aroclor 1260 in hexane

## CHAPTER 10

### MW EXPERIMENTS WITH ORGANIC SOIL

#### 10.1 Ratios of Forward Power to Reflected Power at Different Frequency Range

3g of stock sample B placed in a crucible was placed in sand bath in the center of the cavity, after warm-up of the VFMF. Two sets of experiments measured the Forward and Reflected Power at 0.1 GHz intervals. In the first set, the frequency was increased for 2.40 to 7.50 GHz, in the second set, it was decreased (in 0.1 GHz steps) for 7.50 to 2.40 GHz. The data of Forward Power and Reflected Power was recorded at each setting. The soil sample was changed during measurements to protect the temperature probe. The ratio of F/R was calculated by hand and the average ratio is shown in Figure 10.1.

#### 10.2 Measure the Time for Soil to Reach 100 °C in One GHz Frequency Range

5g stock sample was put in alumina crucible, glass wool and glass beans were placed on the top of the soil . Sweep time =0.1 sec. Two or three measurements were done for each one GHz frequency range. One experiment started at low frequency to high frequency, the other is from high to low frequency. The time results to reach 100°C is the average of two or three measurements (Table 10.1)

**Table 10.1** Time to Reach 100°C in One GHz Frequency Range

Frequency (GHz)	No.. of measurements	Range of time	Average time to reach 100°C
2.4 ~ 3.4	6	1' 57"--7' 44"	4' 12"
3.4 ~ 4.4	2	2' 23"--2' 48"	2' 35"
4.4 ~ 5.4	2	3' 24" --3' 46"	3' 35"
5.4 ~ 6.4	2	3' 15" --3' 24"	3' 19"
6.4 ~ 7.5	2	3' 17". --3' 27"	3' 22"



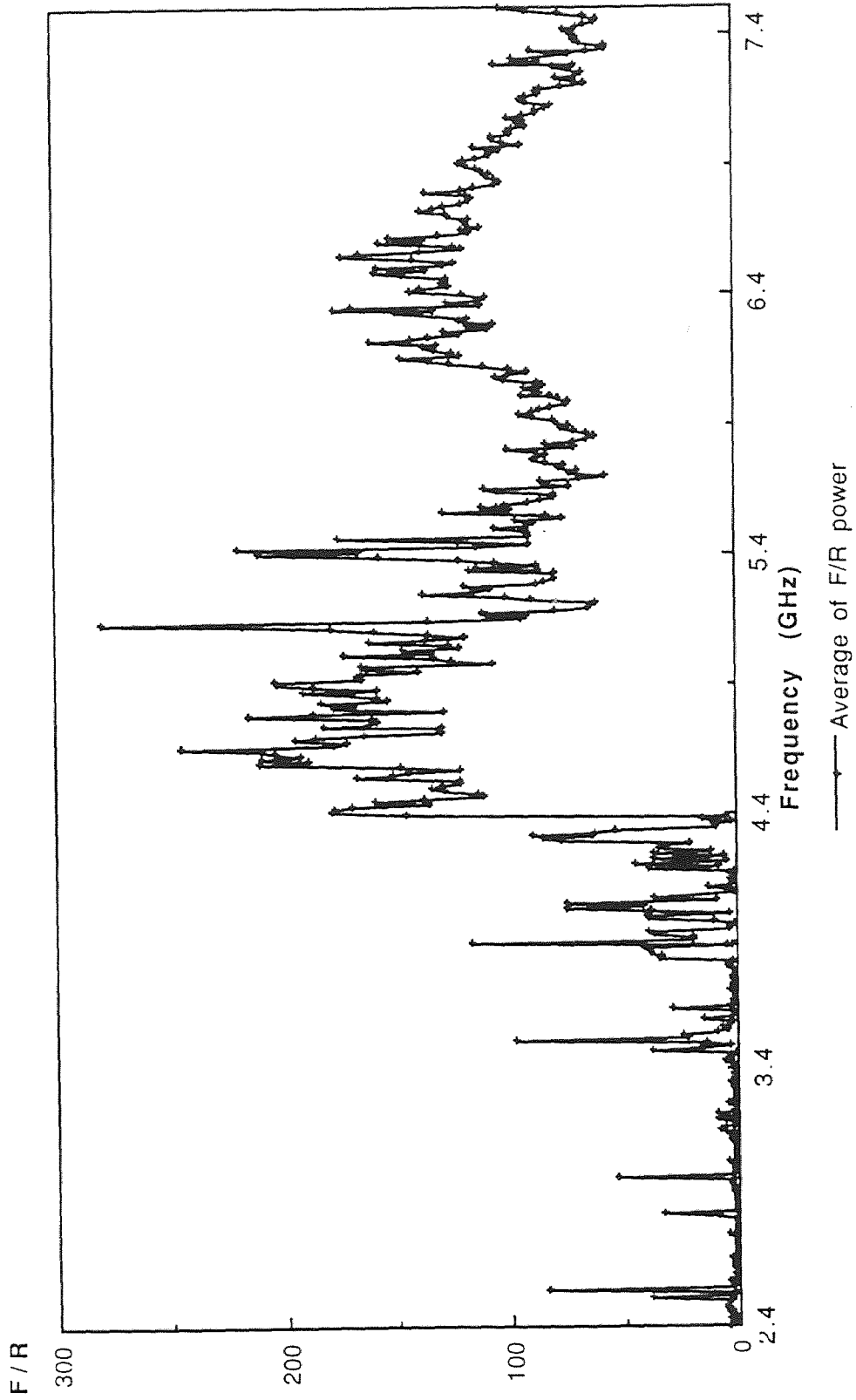

**Figure 10.1** Ratio of Forward to Reflected Power of Vitahume Top Soil at 2.40 to 7.50 GHz (Average of Two Experiments)

From Table 10.1, we can see the time for 4.4 ~ 5.4, 5.4 ~6.4, 6.4 ~ 7.5 GHz is very close, the time is little be longer for 2.4 ~ 3.4 GHz and little shorter for 3.4 ~ 4.4 Hz.. Time to reach 100°C depends on the ratio of F/R over the whole frequency.

### **10.3 Comparison of Extractability of Two Extraction Methods**

#### **10.3.1 Introduction**

In this experiment, PCB#53 contaminated soil was extracted by Soxhlet extraction and Ultrasonic extraction in order to assess the extractability of PCB congeners in these two extraction methods.

Soxhlet extraction is a traditional multistage mass transfer operation. A continuous process is necessary since the compound has a limited solubility in the selected solvent. The soil sample was placed in a Whatman cellulose thimble which was inserted in the extraction chamber. The extracts is fitted to the boiling flask and condenser which is flushed with cold water continuously. A heating mantle was employed to heat the boiling flask. The solvent was heated to boiling, causing the vapors come up to the condenser. The condensed, pure solvent liquid was returned to the extraction chamber where it comes in contact with the solid sample and carry the pollutant through the thimble. When the liquid fills the siphon arm, the solution flows back to the boiling flask because of the siphon action. This procedure can be continue as long as the flask is heated. In this experiment, PCB#53 is extracted using hexane and other solvents (see bellow).

Ultrasonic extraction method was described in the chapter 8.

#### **10.3.2 Instrument and Experimental Condition**

Soxhlet extractor: 34 ID,. with 125 ml round bottom flask, 100 ml of solvent was placed in the flask and 5 grams of PCB #53 soil sample was placed in a cellulose thimble (Whatman 25 × 80 mm ). The extraction time was 24 hours. The final volume was measured and 1.0 ml transferred into a septum vial for GC/MS analysis.

Ultrasonic: VirSonic 475, 25 ml of solvent was used, the extraction time was set for 4 minutes. After extraction, the extract was filtered by vacuum filtration (Buchner funnel). The final volume of the extract was measured and 1.0 ml transferred into the septum vial for GC/MS analysis.

GC/MS: 5890/5970 GC/MS with 59970 Chem Station software.

### 10.3.3 Experimental I

1:3 of Acetone: Hexane and 100% Hexane were used to extract PCB#53 and PCB#65 from the original Vitahume top soil (stock sample B) by utilizing Soxhlet extraction method, The final extracted volume were noted. The results were shown in Table 10.2

**Table 10.2** Soxhlet Extraction Results on Stock Sample B

Soxhlet	Soil W <sub>f</sub> (g)	Solvent	Extracted Volume (ml)	PCB#53 Conc. (ng/ul)	PCB#65 conc. (ng/ul)	Conc. (ug/g)
I	5.02	75% Hexane 25% Acetone	66	0	0	0
II	5.07	100% Hexane	75	0	0	0

### 10.3.4 Experiment II

(1) Two solvents were used in this experiment, one solvent is 100 % hexane, other is 25 % of acetone and 75 % of hexane. Two soil samples contaminated with PCB#53 were weighed and noted. Two sets of Soxhlet apparatus were prepared at the same time. The final extract volumes in the bottom flask was noted respectively and analyzed with GC/MS. The results were shown in Table 10.3.

(2) Similar solvent mixture were used to extract PCB#53 from the contaminated soil by employing Ultrasonic extraction method. The results are shown in Table 10.5.

**Table 10.3** Soxhlet Extraction Results on PCB#53 Contaminated Soil

Soxhlet	Soil W <sub>t</sub> (g)	Solvent	Extracted Volume (ml)	Conc. (ng/ul)	Ave. conc. (ng/ul)	Conc. (ug/g)
I	5.04	75% Hexane 25% Acetone	77	20.49 22.53	21.51	328.63
II	5.09	100% Hexane	62	33.95 33.96	33.955	413.59

### 10.3.5 Conclusion

1. There is no PCB#53 and PCB#65 in top soil.
2. Soxhlet and Ultrasonic method comparison on extracting PCB#53 were listed in Table 10.4. The amount of PCB#53 extracted by Soxhlet extraction method is much higher than by Ultrasonic extraction method when 100% of hexane served as extracting solvent. But for 1:3 of acetone and hexane solvent, these two extraction methods show similar levels of extractibility. For the purpose of our research, Ultrasonic extraction method is employed to extract PCBs, considering the case of operate and time saving.

**Table 10.4** Two Extraction Method Comparison

Extraction Method	Solvent	Conc (ug/g)	Extraction Efficiency (%) a
Soxhlet Extraction	1:3 of Acetone :Hexane	328.63	82.2
	100% of Hexane	413.59	103
Ultrasonic Extraction	1:3 of Acetone : Hexane	351.63	87.9
	100% Hexane	161.47	40.4

a: Original soil concentration is 400 ug/g.

## 10.4 Solvent Comparison with Ultrasonic Extraction Method

### 10.4.1 Experiment

In this experiment, PCB#53 contaminated soil sample was extracted by Ultrasonic method and different solvents served as extract solvents. The results were shown in Table 10.5.

**Table 10.5 Solvent Comparison by Ultrasonic Extraction on PCB#53 Soil Sample**

Solvent	Conc. <sup>a</sup> (ng/ul)	Average (ng/ul)	Extracted volume (ml)	Soil Wt (g)	Conc. (ug/ul)	Extraction efficiency (%) <sup>c</sup>
10% Acetone 90% Hexane	62.46 63.12	62.79	13.4	3.02	278.60	69.65
25% Acetone 75% Hexane	70.31 79.75	75.03	14.2	3.03	351.63	87.9
50% Acetone 50% Hexane	71.90 55.28	63.59	16.8	3.03	352.58	88.15
100% Hexane	39.48 49.78	44.63	15.7	5.05	138.75	40.37 <sup>b</sup>
	55.11 51.85	53.48	16.0	5.01	170.79	
	48.99 48.35	48.67	18.0	5.01	174.86	
100% Methy- -lene chloride	40.36 42.58	41.47	16.4	3.04	223.72	55.93
50% Methyl- -ne chloride 50% Acetone	40.73 44.86	42.795	18.0	3.03	254.23	63.56

a--Two GC/MS injections for each sample.

b--Based on average conc.(ug/g) of three samples

$$(138.75+170.79+174.86)/3=161.47 \text{ (ug/g)}$$

c--Original soil concentration is 400 ug/g.

#### 10.4.2 Conclusion

1:3 of acetone : hexane has higher extractable efficiency than other solvents. For our purpose, 100% of Hexane will be used in the following experiments.

### 10.5 Behavior of Soil Contaminated with PCB#53 in a Variable Frequency Microwave Field

#### 10.5.1 Experiment

The top soil was contaminated with PCB#53 to levels of Ca. 400 ppm (weight/weight). Samples were irradiated at different frequency ranges and different lengths of time ( to reach 100°C). In two batches the crucibles were placed in an insulating sandbath during irradiation to prevent heat losses to the environment. In both batches high power levels

were used. Two samples for each one GHz frequency range were measured in the first batch and one sample for one each GHz frequency range was measured in the second batch.

**Table 10.6** MW Treatment Condition on PCB#53 Soil (First and Second Measurement, SW=0.1 second)

MW (GHz)	First Measure			Second Measure		
	Time	FP	RP	Time	FP	RP
2,4-7.5 #1	2'55"	110-123	27-36	3'48"	91-112	18-40
2.4-7.5 #2	3'13"	110-125	23-33			
2.4-3.4 #1	1'58"	104-106	31-44	2'45"	86-110	5-11
2.4-3.4 #2	1'45"	108-110	37-42			
3.4-4.4 #1	2'36"	104-105	31-44	3'30"	93-100	16-24
3.4-4.4 #2	2'39"	101-106	31-46			
4.4-5.4 #1	1'55"	134-139	30-35	3'04"	124-131	38-42
4.4-5.4 #2	2'10"	127-134	33-39			
5.4-6.4 #1	2'32"	104-111	16-23	3'58"	115-119	334-51
5.4-6.4 #2	2'48"	103-109	14-23			
6.4-7.4 #1	2'49"	96-122	3-16	3'58"	112-115	30-47
6.4-7.5 #2	3'10"	82-120	5-11			

Note: "Time" is time length that sample is heated to 100°C .

FP is forward power

RP is reflected power

The microwave measurement parameters and concentration analyzed by GC/MS are shown in Table 10.6 and 10.7 and 10.8. Table 10.9 shows the comparative results for both batches and the reduction of extractable PCB. Difference in blank extracts is due to use different batch of soil.

Table 10.7 First Batch of Experiment on PCB#53 Soil Sample

MW (GHz)	Conc. <sup>a</sup> (ng/ul)	Average conc. (ng/ul)	Extracted volume (ml)	sample weight (g)	Conc. <sup>b</sup> (ug/g)	Average (ug/g)
Blank #1 <sup>c</sup>	39.48 49.78	44.63	15.7	5.05	138.75	161.47
Blank #2	55.11 51.85	53.48	16.0	5.01	170.79	
Blank #3	48.99 48.35	48.67	18.0	5.01	174.86	
2.4-7.5 #1	38.85 39.90	39.375	16.1	5.05	125.61	131.07
#2	42.84 47.23	45.035	15.40	5.08	136.52	
2.4-3.4 #1	53.30 54.04	53.67	17.0	5.03	181.39	179.78
#2	46.79 48.87	47.83	18.7	5.02	178.17	
3.4-4.4 #1	50.03 44.96	47.50	16.6	5.06	155.81	164.83
#2	58.29 57.61	57.95	15.0	5.0	173.85	
4.4-5.4 #1	55.41 43.60	49.51	16.6	5.0	164.36	157.17
#2	46.12 43.33	44.73	16.8	5.01	149.98	
5.4-6.4 #1	52.19 51.26	51.725	16.2	5.02	166.92	162.76
#2	48.34 47.20	47.77	16.6	5.00	158.59	
6.4-7.5 #1	58.72 50.69	54.71	17.3	5.02	188.53	179.5
#2	51.63 53.81	52.72	16.2	5.01	170.47	

a: Two injections in GC/MS for each sample,

b: ug of PCB#53 / g of soil.

c: No MW irradiation (blank extracts)

Table 10.8 Second Batch of Experiments with PCB#53 Soil Sample

Treatment	Conc. <sup>a</sup> (ng/ul)	Average conc.(ng/ul )	Extracted volume(ml )	Sample weight(g)	Conc. <sup>b</sup> (ug/g)	Average (ug/g)
Blank#1 <sup>c</sup>	11.40	14.473	14.4	4.01	51.97	53.385
	14.39					
	17.63					
Blank #2	11.53	12.177	18.0	4.0	54.80	
	10.01					
	4.99					
2,4-7.5	8.046	10.473	17.2	4.02	44.81	
	8.984					
	14.39					
2.4-3.4	11.83	12.347	18.0	4.02	55.29	
	13.98					
	11.23					
3.4-4.4	8.086	9.684	17.4	4.06	41.50	
	11.78					
	9.185					
4.4-5.4	11.90	11.193	18.3	4.05	50.58	
	11.01					
	10.67					
5.4-6.4	10.93	13.110	17.2	4.04	55.81	
	12.05					
	16.35					
6.4-7.5	7.085	9.571	16.8	4.05	39.70	
	9.907					
	11.72					

a: Three injections in GC/MS for each sample. b: ug of PCB#53 / g of soil.

c: No MW irradiation (blank extracts).

Table 10.9 Reduction of Extractable PCB#53 in MW Treatment

MW treatment (GHz)	Concentration (ug/ul)		Reduction of PCB(%).		Average of reduction of extractable PCB#53 (%)
	First batch	Second batch	First batch	Second batch	
No MW	161.47	53.39			
2.4--7.5	131.07	44.81	18.83	16.1	17.5
2.4--3.4	179.78	55.29	0	0	0
3.4--4.4	164.83	41.50	0	22.3	11.2
4.4--5.4	157.18	50.58	2.7	5.3	4
5.4--6.4	162.76	55.81	0	0	0
6.4--7.5	179.50	39.70	0	25.6	12.8



### 10.5.2 Conclusion

(1) When soil sample was heated to 100°C in VFMF, the reduction of extractable PCB#53 is very low in one GHz frequency range. The length of irradiation seems to be not significant for the reduction of extractable amounts of PCB#53.

(2) A consistent and reproducible reduction of the extractable PCB is seen when soil is heated to 100°C at the total available frequency range (2.40--7.50 GHz). There was also the highest average reduction (17.5%) achieved.

(3) Reductions were recorded with smaller frequency ranges, but not consistently, and smaller (on average).

(4) The length of exposure does not seem to effect the reirradiation / extraction of PCB.

(5) It is possible, that the distribution of the electromagnetic field at a one GHz range is not uniform enough to allow heating of the sample at similar rate as when the whole frequency range is used.

(6) Generally, the reduction of extractable PCB#53 was not vary large.

## 10.6 Behavior of Soil Contaminated with PCB#65 in a Variable Frequency Microwave Field

### 10.6.1 Experiment

**Table 10.10** MW Treatment Conditions on Soil Contaminated with PCB #65  
(First and Second Measurement)

MW(GHz)	First Measure			Second Measure			Average time to reach 100°C
	Time	FP	RP	Time	FP	RP	
2,4-7.5 #1	2'45"	115-140	27-53				2'41"
2.4-7.5 #2	2'23"	121-151	30-50				
2.4-7.5 #3	2'55"	121-145	29-57				
2.4-3.4	2'36"	116-121	22-60	1'58"	109-113	45-56	2'17"
3.4-4.4	3'17"	115-122	34-59	4'02"	111-117	39-58	3'39"
4.4-5.4	1'57"	146-155	35-49	2'13"	136-142	39-42	2'05"
5.4-6.4	2'39"	106-116	18-31	2'45"	106-109	14-22	2'42"
6.4-7.5	2'35"	104-128	6-17	2'19"	96-107	7-17	2'27"

Stock sample B was contaminated with PCB#65 to levels of Ca. 400 ppm (weight/weight). Samples were irradiated for different lengths of time in the variable

frequency microwave field. In both batches high power levels and an insulating sandbath were used. The soil temperatures never exceeded 100°C, as seen in similar experiments with PCB#53. Microwave parameters were recorded in Table 10.10. Different in one GHz ranges (in time to reach 100°C) reflects non-uniformity of field: a slightly different location of irradiation. The concentration analyzed by GC/MS and calculated amount of recoverable PCB#65 is listed in Table 10.11 and 10.12. The reduction of extractable PCB#65 is shown in Table 10.13.

**Table 10.11** First Experiment with PCB#65

Treat-ment	Conc. <sup>a</sup> (ng/ul)	Average conc.(ng/u l)	Extracted volume(ml )	sample weight(g )	Conc. <sup>b</sup> (ug/g)	Average (ug/g)
Blank#1 <sup>c</sup>	11.63 12.11	11.87	15.6	5.03	36.81	35.78
Blank#2	10.76 11.45	11.105	16.8	4.03	46.29	
Blank#3	6.087 4.591	5.339	18.2	4.01	24.23	
#1 2.4-7.5	7.220 9.622	8.421	16.9	4.03	35.31	31.94
#2 2.4-7.5	6.011 7.314	6.668	15.8	4.01	26.27	
#3 2.4--7.5	6.500 9.184	7.842	17.6	4.03	34.25	
2.4-3.4	4.657 5.128	4.893	16.8	4.03	20.396	
3.4-4.4	5.111 6.192	5.652	17.6	4.01	24.8	
4.4-5.4	7.191 6.824	7.0075	17.4	4.00	30.48	
5.4-6.4	3.768 6.847	5.3075	16.6	4.02	21.9	
6.4-7.5	6.103 5.081	5.592	18.7	4.06	25.76	

a: Two injections in GC/MS for each sample; b: ug of PCB#65 / g of soil; c: No MW irradiatio

**Table 10.12** PCB #65 Soil Extraction and MW Treatment Results in the Second Experiment

treatment	Amount <sup>a</sup> (ng/ul)	Average (ng/ul)	Extracted Volume (ul)	sample weight (g)	Conc. <sup>b</sup> (ug/g)	Ave. conc. (ug/g)
Blank#1 <sup>c</sup>	4.868	4.51	16.9	4.03	18.91	13.288
	4.152					
Blank#2	2.643	2.132	18.0	4.04	9.499	
	1.621					
Blank#3	2.968	2.773	16.4	4.03	11.276	
	2.578					
2.4- 3.4	0.2711 1.615	0.94305	16.9	4.06	3.926	
3.4- 4.4	2.721 2.963	2.842	17.4	4.03	5.219	
4.4 - 5.4	0.6813 1.596	1.13865	17.8	4.03	5.029	
5.4 - 6.4	0.6441 1.673	1.15855	17.9	4.00	5.185	
6.4-7.5	3.189 3.585	3.387	18.0	4.03	15.128	

a: Two injections for each sample.

b: ug of PCB#65 / g of soil.

c: No MW irradiation (blank extracts).

**Table 10.13** Reduction of Extractable PCB#65 in MW Treatment

MW treatment (GHz)	PCB 65 in soil (ug/ul)		Reduction range of the extractable amount of PCB (%).	Average reduction of extractable PCB#65 (%)
	First batch	Second batch		
No MW	35.78	13.228		
2.4--7.5	31.94	-----	1.3 to 26.6	10.7
2.4--3.4	20.40	3.926	43.0 to 70.3	56.7
3.4--4.4	24.8	5.219	30.7 to 60.6	45.6
4.4--5.4	30.48	5.029	14.8 to 61.98	38.39
5.4--6.4	21.9	5.185	38.8 to 60.8	49.8
6.4--7.5	25.76	15.128	0 to 28.0	28.0

## 10.6.2 Conclusion

(1) Although the temperature didn't go over 100°C, the results of two batch experiments show a certain reduction efficiency of extractable PCB#65. Here, the whole spectra of frequencies amounted to the lowest average reduction (10.7%); whereas individual frequency ranges showed a average of up to 56 % reduction of extractable PCB#65. These was significant variation between single GHz range alone (most likely due to the non-uniformity of the field).

(2) It is possible that frequency specific effects are seen these: the individual frequency range couple differently to the molecular structure of PCB #53 and #65, respectively.

## 10.7 Temperature Effect on Soil Contaminated with PCB#53

### 10.7.1 Experiment

From previous experiments, it can be seen that the frequency of range did result in differences in PCBs treatment. Another important factor is the soil temperature. In this set of experiments, first, we tried to heat the soil sample by altering the sweeprate (from 0.1 to sec./sweep to 1 sec and 10 sec/sweep, using the full frequency range in order to save heating time. The rate of temperature increase didn't get improve (Table 10.14). These results that the sweeprate of 0.1 sec./sweep 0.1 sec./sweep is the best choice.

**Table 10.14** The Relation Between Sweeprate and Heating Rate

Sample mass (g)	Sweeprate (sec./sweep)	Temperature (°C)		Time	°C / min.
		Initial	Reached		
4.06	0.1	26.94	85.26	8'14"	7.1
3.98	10	24.21	85.41	11'45"	5.2
4.06	0.1	85.26	100	3'41"	4.0
3.98	1	85.41	100	4'39"	3.1

We then tried to find some materials that can increase soil sample temperature, because the quartz sand did not result in temperature above 100°C. Hematite and

magnetite (WARD'S Natural Science Establishment, INC) were selected to be in place of sand.

**Table 10.15** Experiments of the Temperature Effect (2.4--7.5 GHz)

Sample description (inserting bath)	Conc. <sup>a</sup> (ng/ul)	Average conc. (ng/ul)	Extracted volume (ml)	sample weight (g)	Conc. <sup>b</sup> (ug/g)	Ave. conc. (ug/g)	Reduction <sup>c</sup> %
Blank #1	22.98 15.81	19.395	10	3.98	48.73	42.02	0
Blank #2	8.271 8.684	8.4775	16.2	3.89	35.30		
117°C <sup>d</sup> (quartz sand)	7.392 5.891	6.6415	16	3.96	26.83	26.83	36.15
170°C (#1) (hematite)	5.471 5.988	5.7295	15.6	4.06	22.01	18.594	47.6
170°C (#2) (hematite)	58.29 57.61	3.5535	17.0	3.98	15.178		
170°C (#2) (hematite) glass wool <sup>e</sup>	0 0	0	16.2	0	0	0	

a: Two injection for each sample.

b: ug of PCB#53 / g of soil

c: Reduction efficiency of extractable PCB#53 compared to blanks

$$Reduction(\%) = 100 - \frac{ug / g \times 100}{42.02}$$

d: 117°C is the maximum temperature for soil sample sitting in white sand bath.

e: TIC and SIC of glass wool and glass bead extract solution are shown in Figure 10.2

Hematite not only showed a higher heating rate than magnetite (Table 10.14), but also its temperature continuously increased without a limit (>200°C). Therefore hematite was chosen to do this experiments and the soil sample was heated to 170°C. Two PCB#53 contaminated soil samples were run, one of it with glass wool and glass beads in order to trap / condense PCB#53 during MW irradiation.. If it is volatilized it, we will condense on the cooler glass wool and can be extracted. Full frequency and sweep rate of 0.1 second was selected for this experiment. The experimental results are shown in

Table 10.15 and reduction efficiency of extractable PCB#53 with temperature is shown in Figure 10.1 (data from Table 10.16 which is from Table 10.7, 10.8, 10.15)

**Table 10.16** Reduction Efficiency (%) of Extractable PCB#53 at Different Temperatures

Sample	Soil temperature		
	100°C	117C°	170°C
1	22.2	36.2	47.6
2	15.5		63.9
3	16.1		
Average	17.93	36.2	55.75

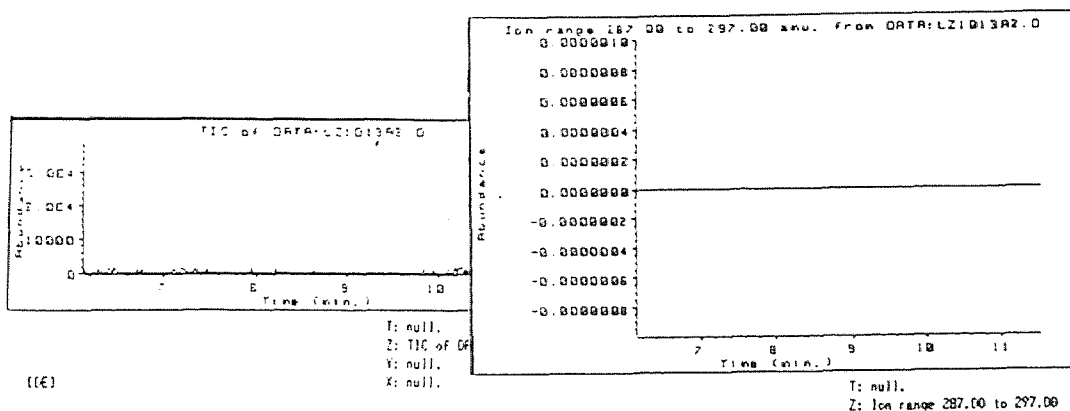

**Figure 10.2** TIC and SIC of glass wool and glass bead extract solution

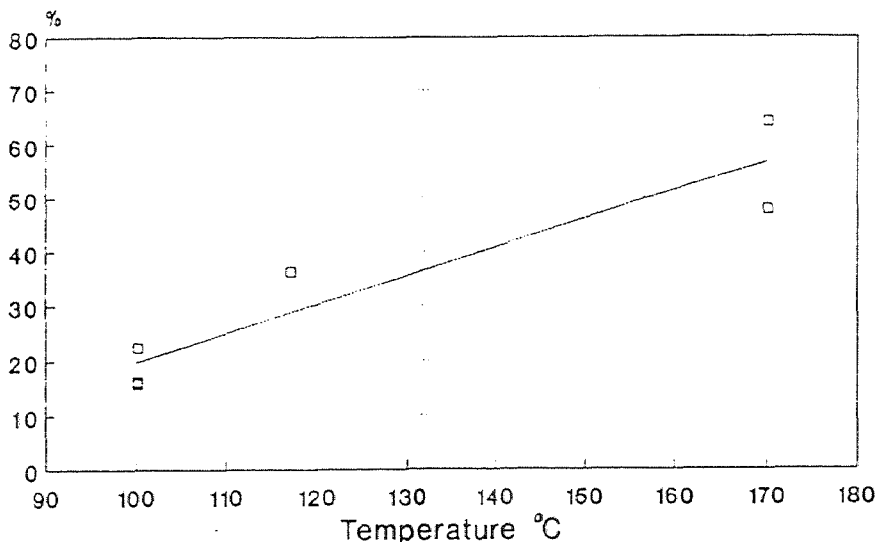

**Figure 10.2** Reduction efficiency tendency of extractable PCB#53 in relation to the soil temperature

### 10.7.2 Conclusion

1. There is no PCB#53 in the glass wool and glass beads extract solution in the high temperature (=170°C). According to these results, MW treatment does not cause PCB#53 volatilize.
2. The tendency of reduction efficiency of extractable PCBs increases significantly as the soil temperature goes up. When the temperature in soil sample reaches 170°C, the reduction efficiency of extractable PCB#53 reaches an average 55 %.

### 10.7.3 Suggestion

Because temperature is a very important factor for increasing the reduction of extractable PCBs, we expect to find even high reduction at high temperatures. Future experiments should use a material that heats the soil sample to >200 °C to study the effect on PCB extractability. In addition, these experiments should be repeated with PCB#65, to determine whether PCB#65 is found condensed on glass wool (since it is more volatile than PCB #53); High concentration of PCBs in soil should be used to study volatilization and extractability at these concentration. Furthermore the possibility of frequency specific effects (as possibly seen with PCB#65) are worth investigation.

## APPENDIX A

### FIGURES OF CHAPTER 6

The experimental results of Chapter 6 are shown in Figure A.1 to Figure A.8.3.



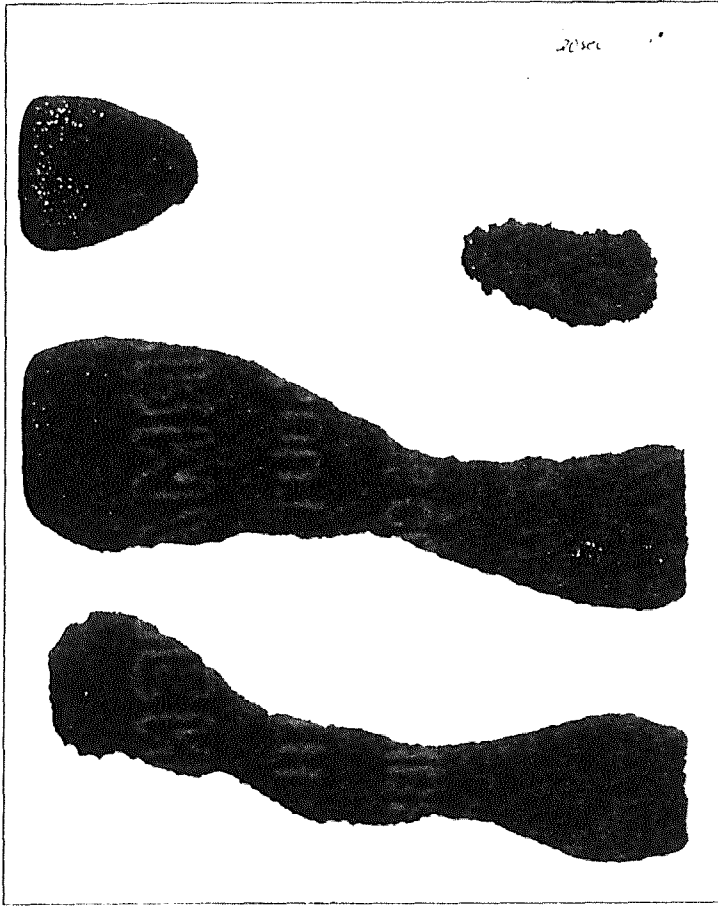

Figure A.1 A thermal paper between two styrofoam blocks (20 sec).

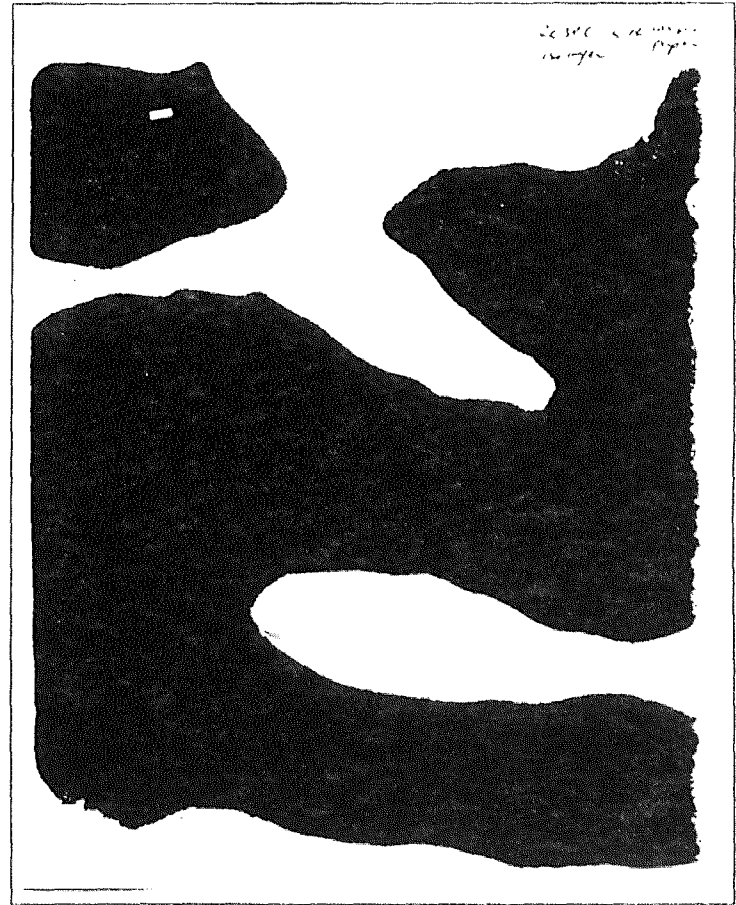

Figure A.2 A carbon paper with two thermal paper and plus styrofoam blocks (20 sec).

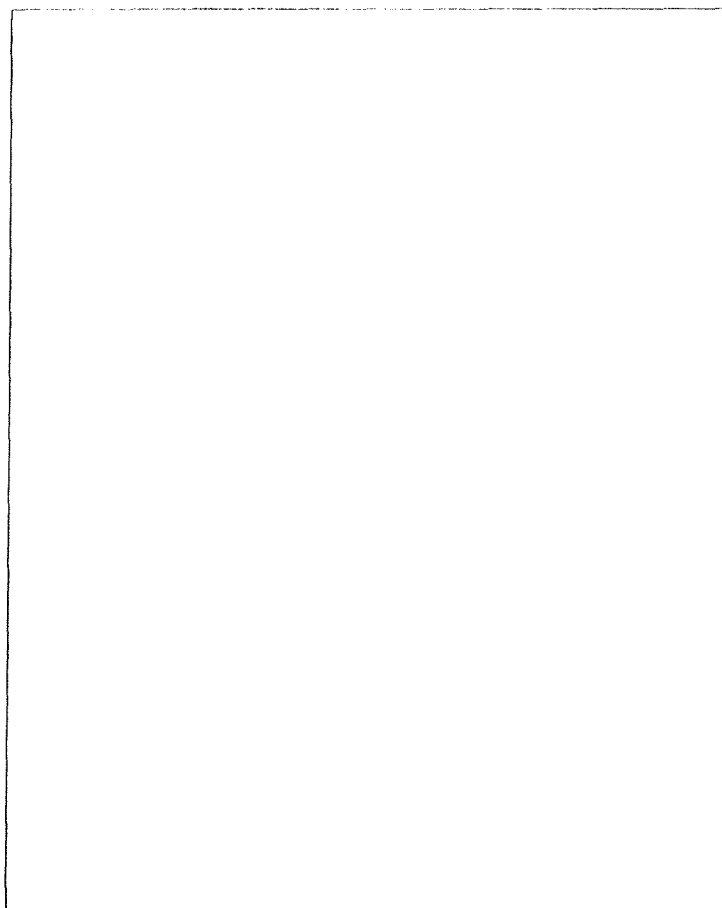

Figure A.3.1 The top layer of thermal paper (20 sec).

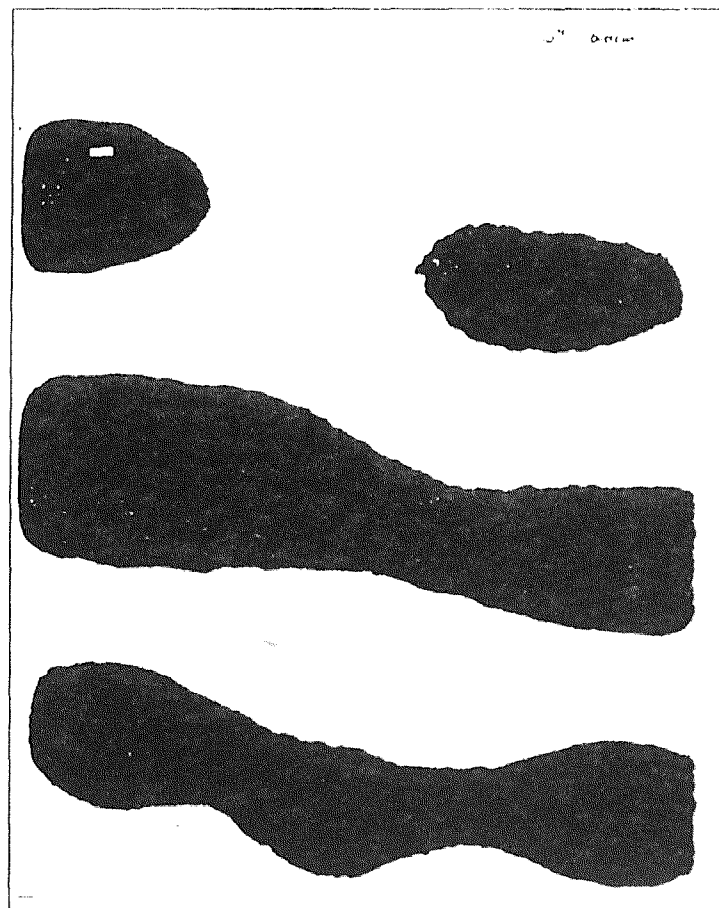

Figure A.3.2 The bottom layer of thermal paper (20 sec).

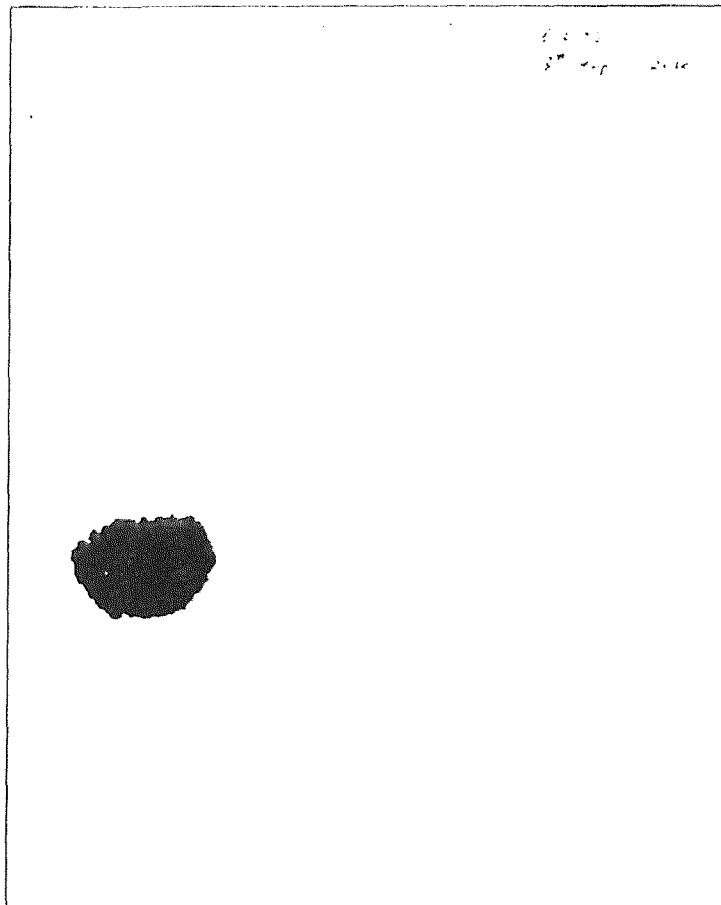

Figure A.4.1 The top layer of thermal paper (20sec).

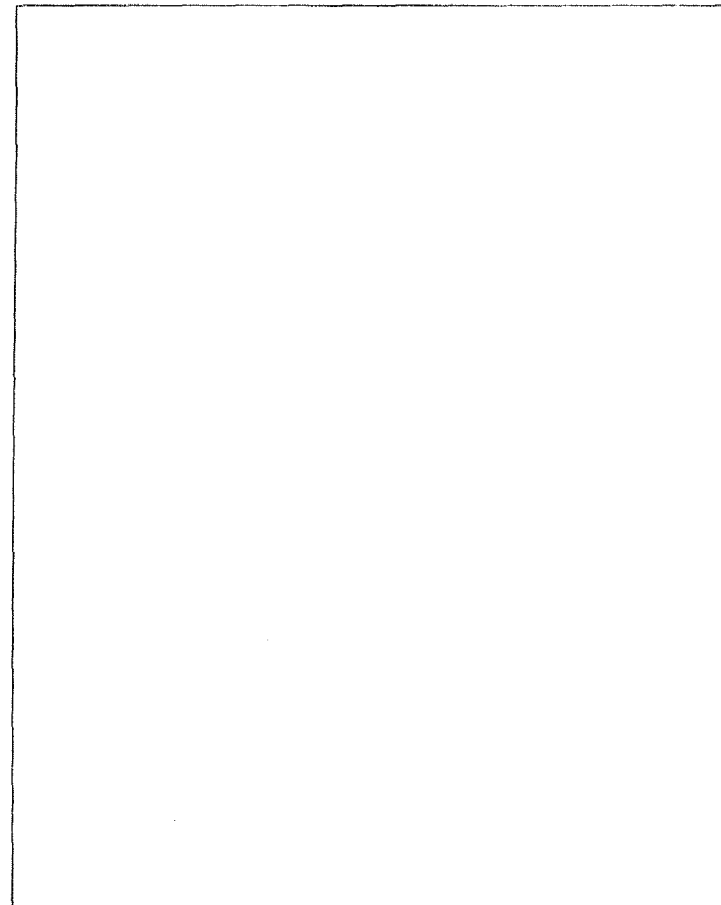

Figure A.4.2 The middle layer of thermal paper (20 sec).

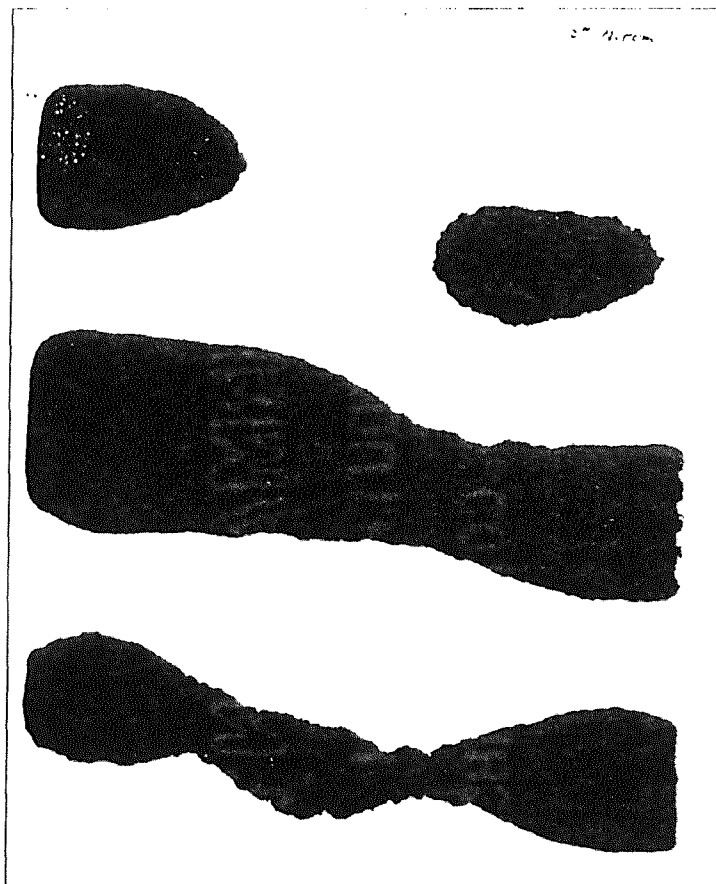

Figure A.4.3 The bottom layer of thermal paper (20sec).

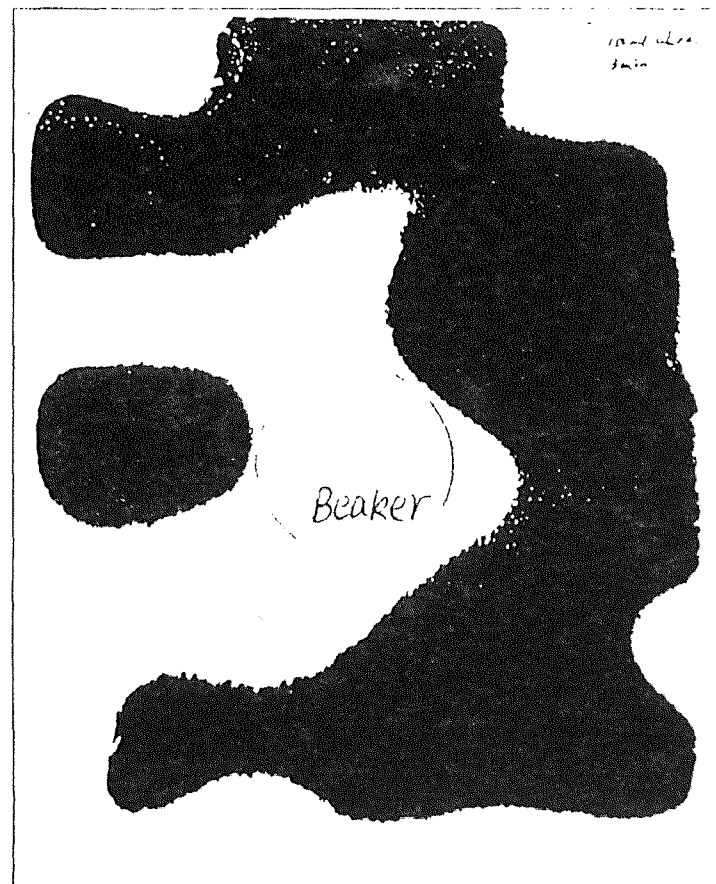

Figure A.5.1 The load volume = 150 ml (3 min).

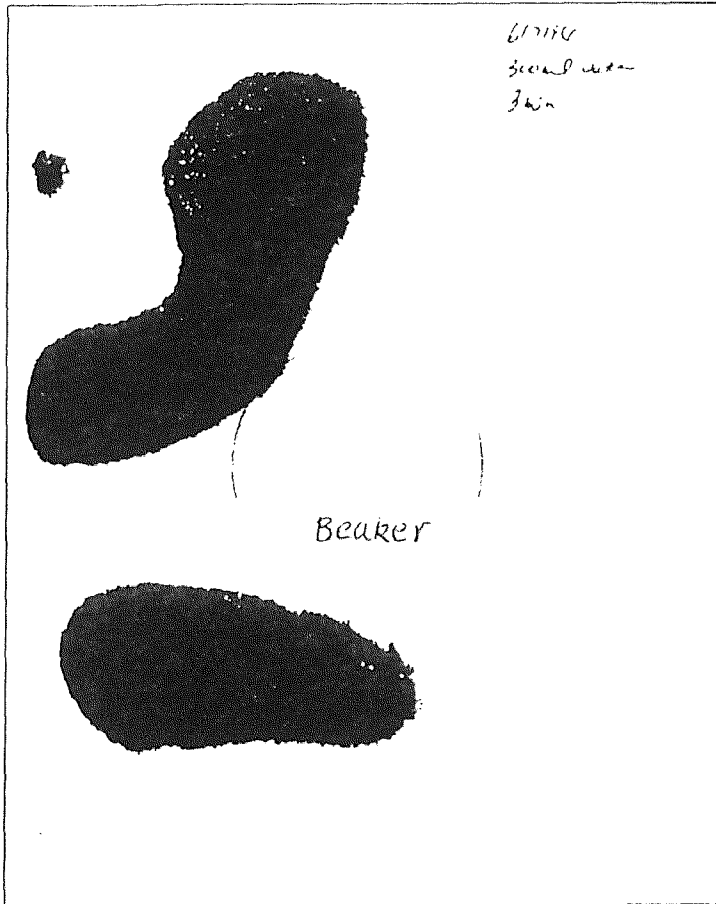

Figure A.5.2 The load volume = 300 ml (3 min).

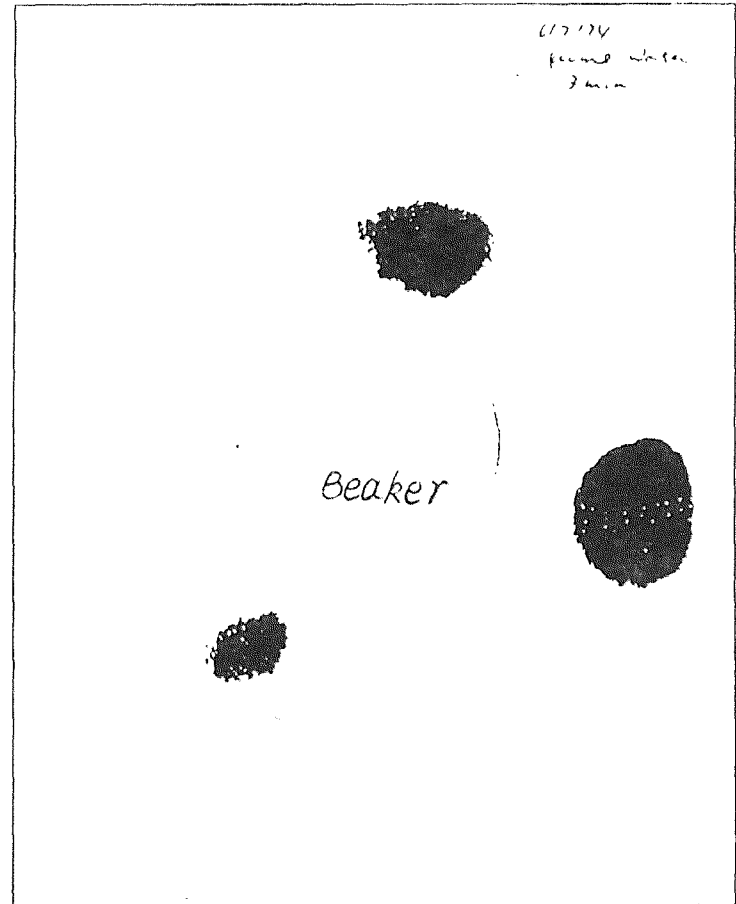

Figure A.5.3 The load volume = 400 ml (3 min).

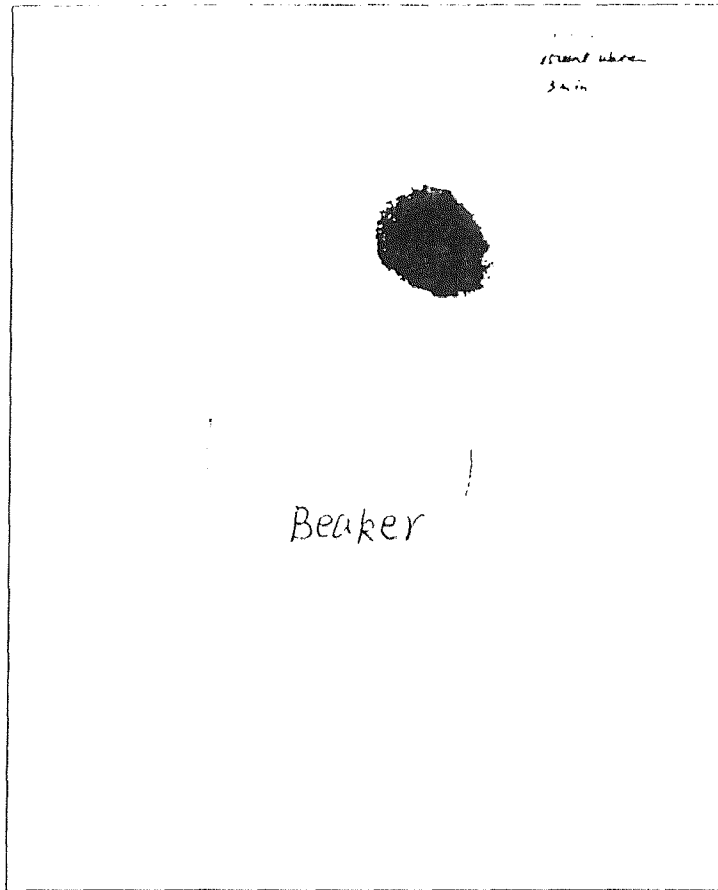

Figure A.5.4 The load volume = 500 ml (3 min).

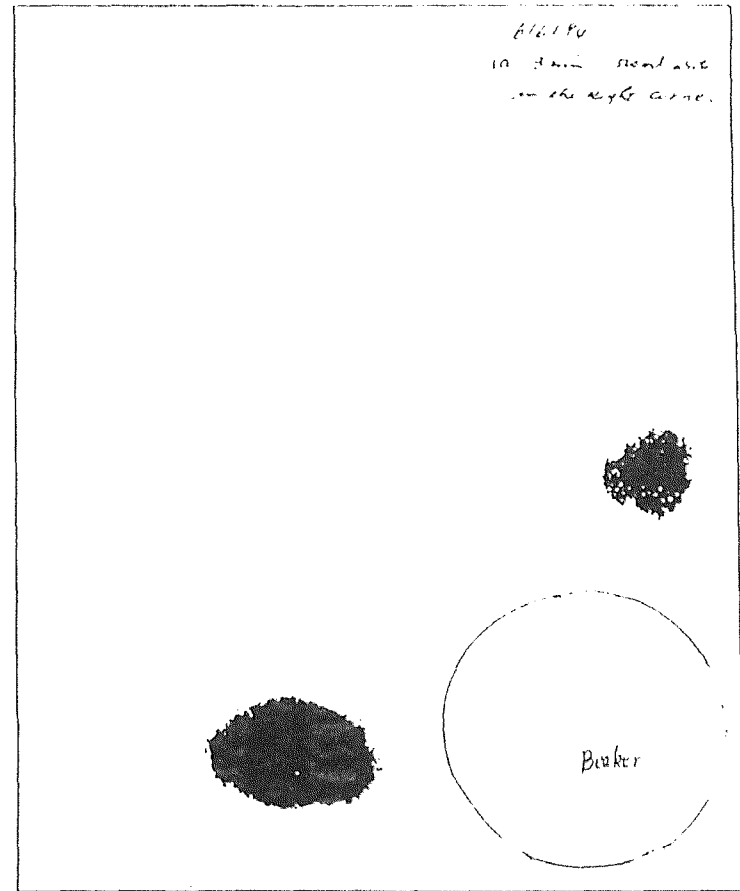

Figure A.6.1 The load with 500 ml in position (a) . (3min) .

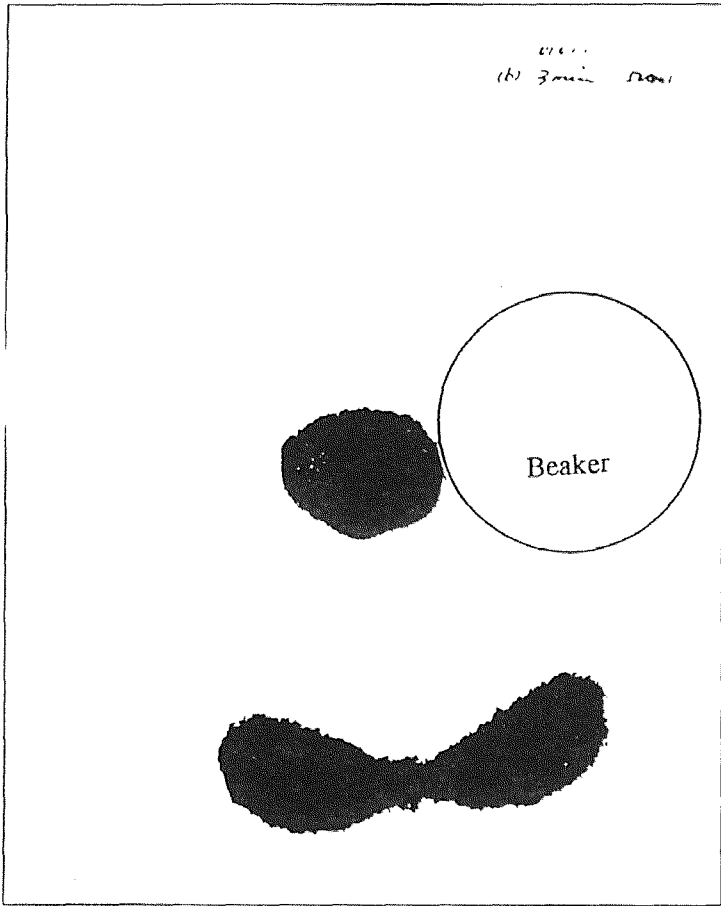

Figure A.6.2 The load with 500 ml in position (b) (3min).

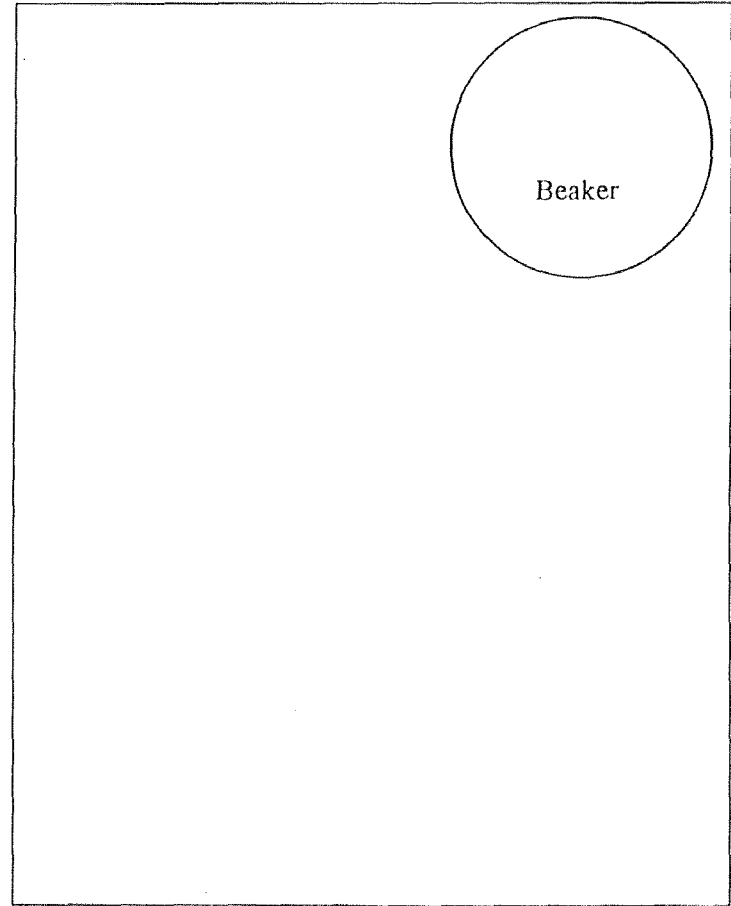
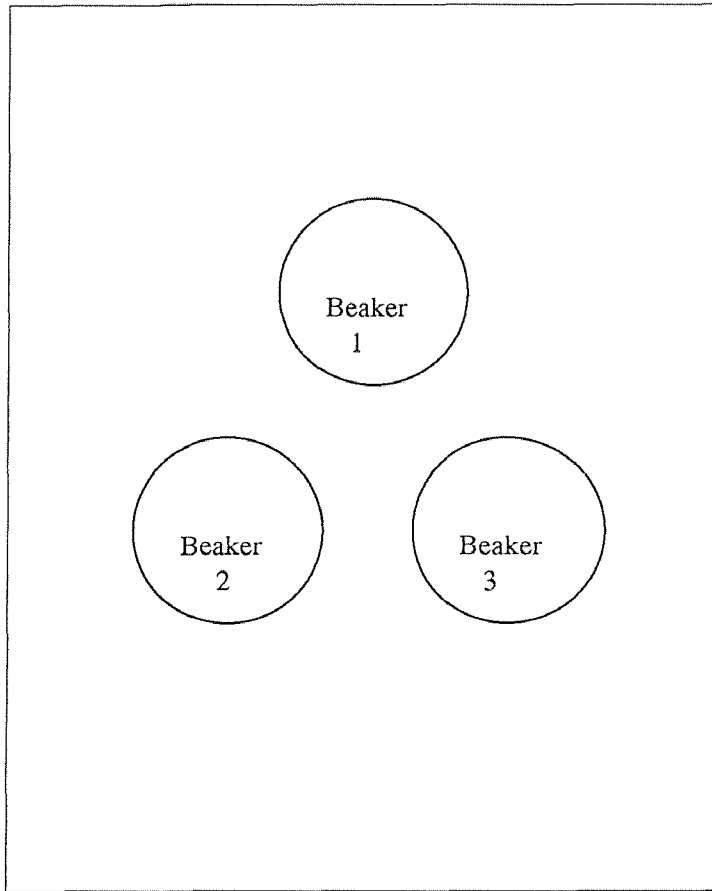
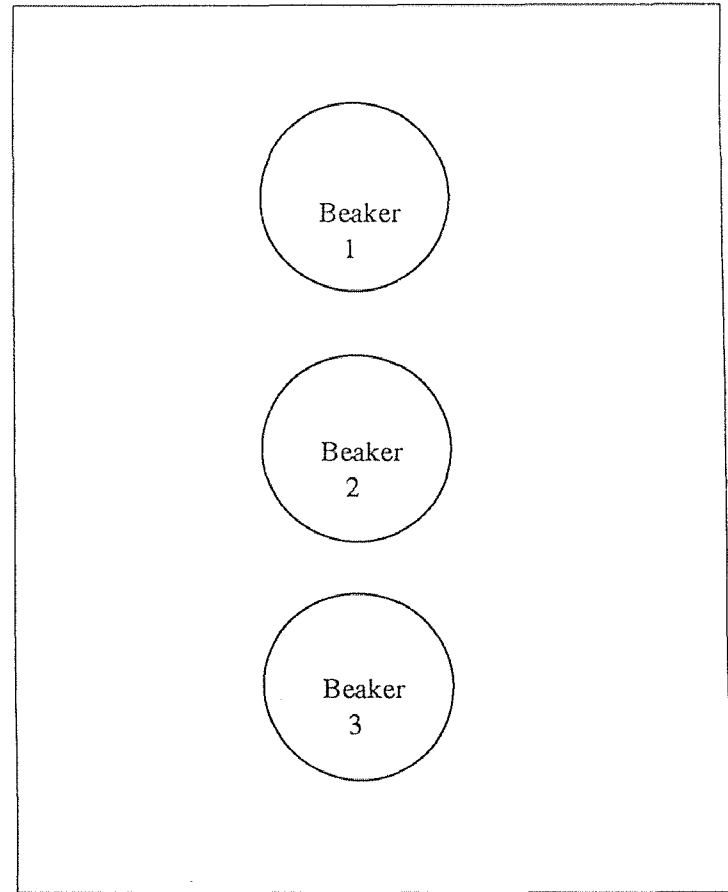

Figure A.6.3 The load with 500 ml in position (c) (3min).



**Figure A.7.1** The load with 3 \* 150 ml in position (a) (5min).



**Figure A.7.2** The load with 3 \* 150 ml in position (b) (5min).



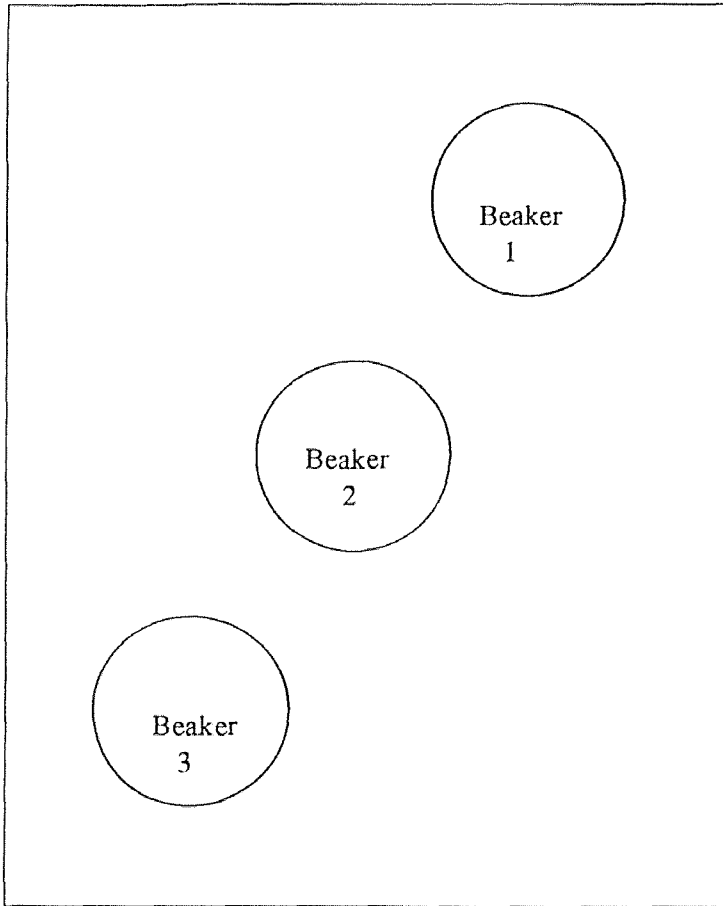

Figure A.7.3 The load with 3 \* 150 ml in position (c) (5min).

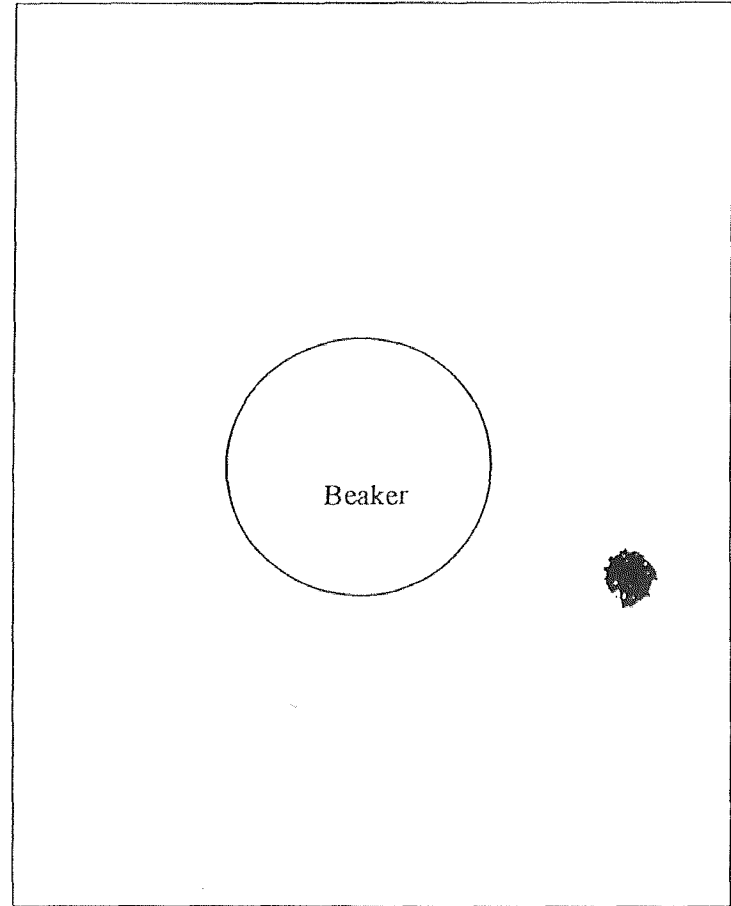

Figure A.8.1 The load with 500 ml (7 min)

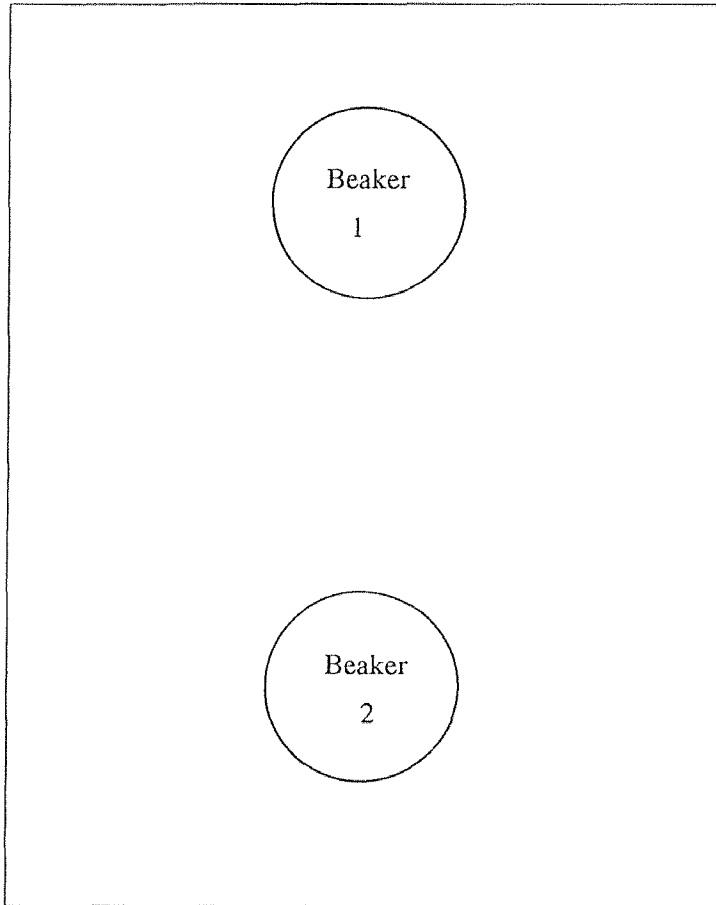

Figure A.8.2 The load with 2 \* 250 ml (7 min) .

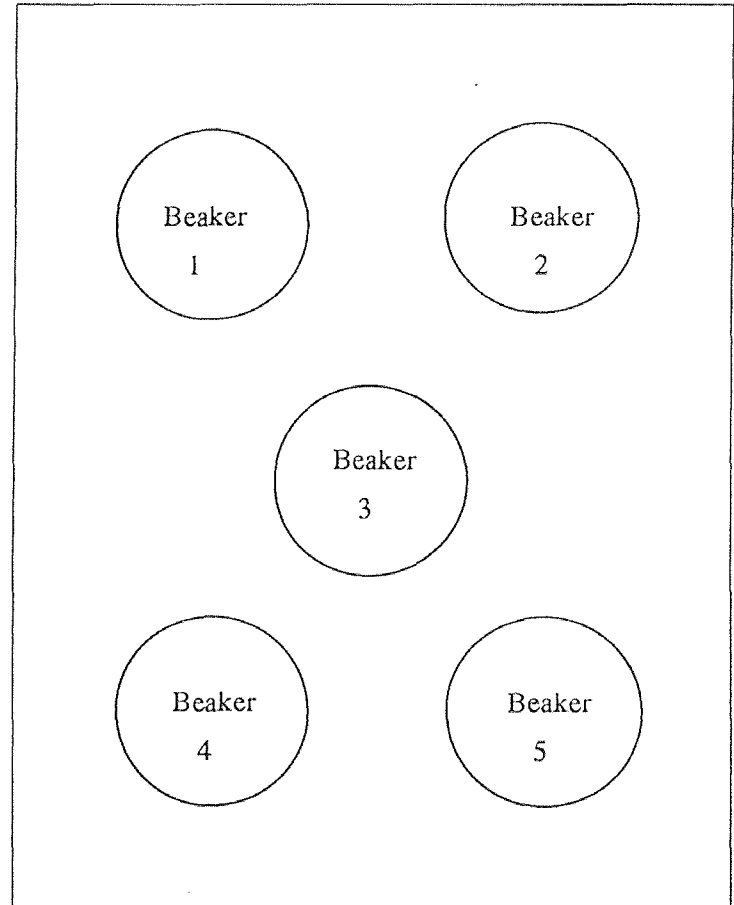

Figure A.8.3 The load with 5 \* 100 ml (7 min) .

## APPENDIX B

### FIGURES OF CHAPTER 7

The experimental results of Chapter 7 are shown in Figure B.1 to Figure B.21.



Figure B.1 cw = 2.45 GHz. Exposure time = 40 sec .

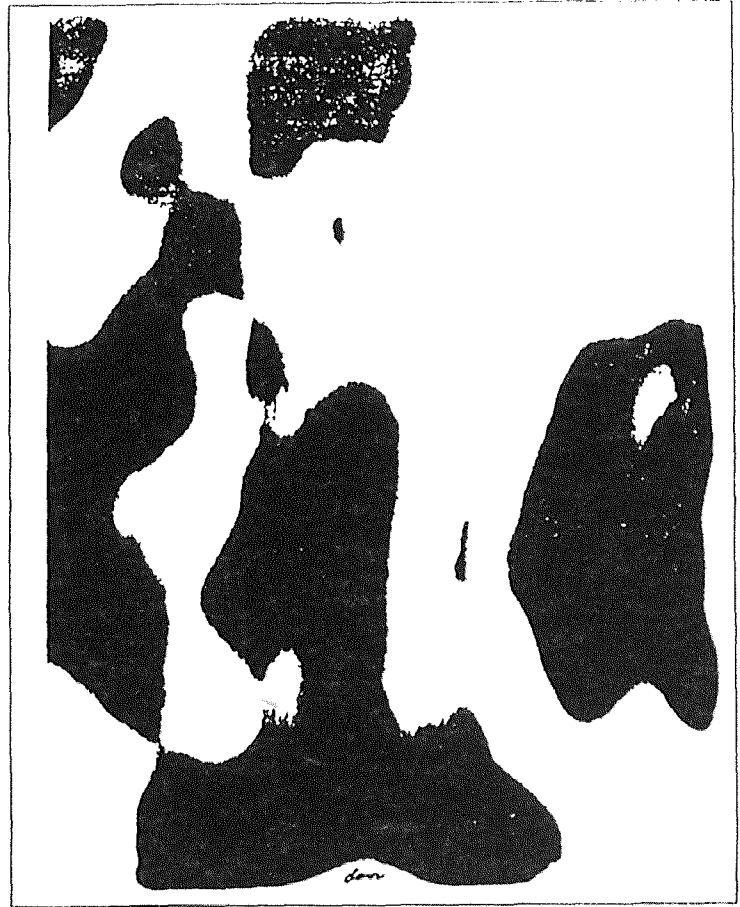

Figure B.2 cw = 2.45 GHz. Exposure time = 30 sec .

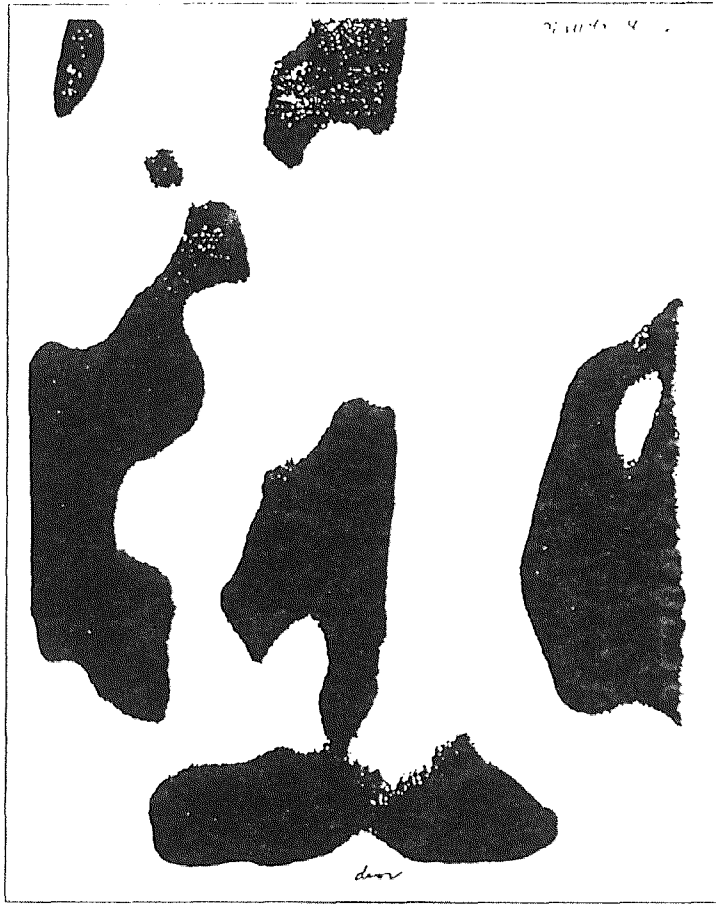

Figure B.3 cw = 2.45 GHz. Exposure time = 25 sec.

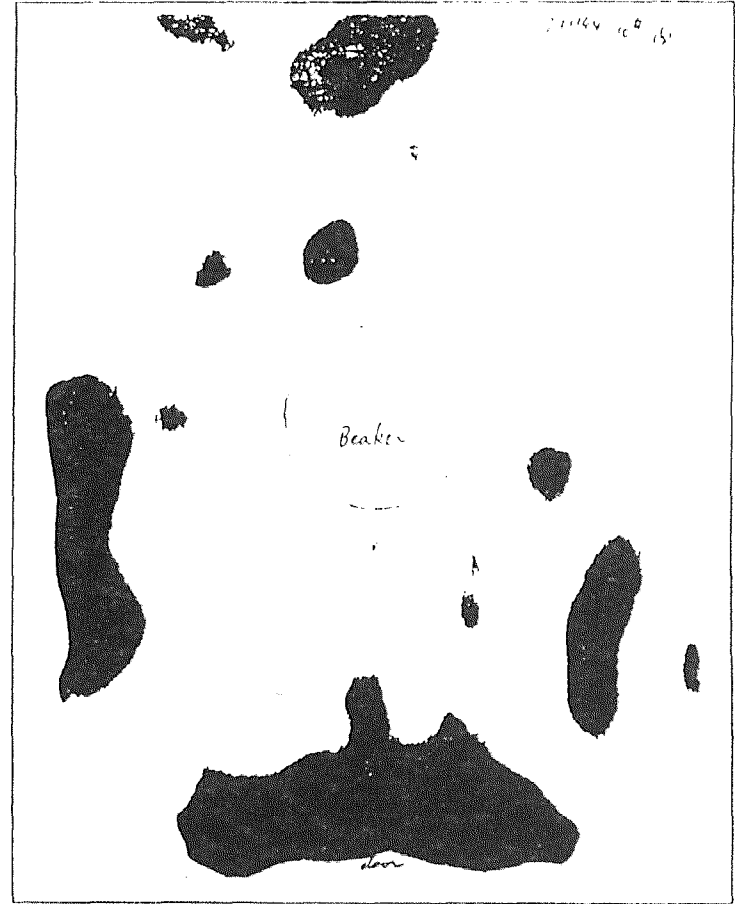

Figure B.4 cw = 2.45 GHz. The load with 100 ml water in position (a), exposure time = 25 sec.

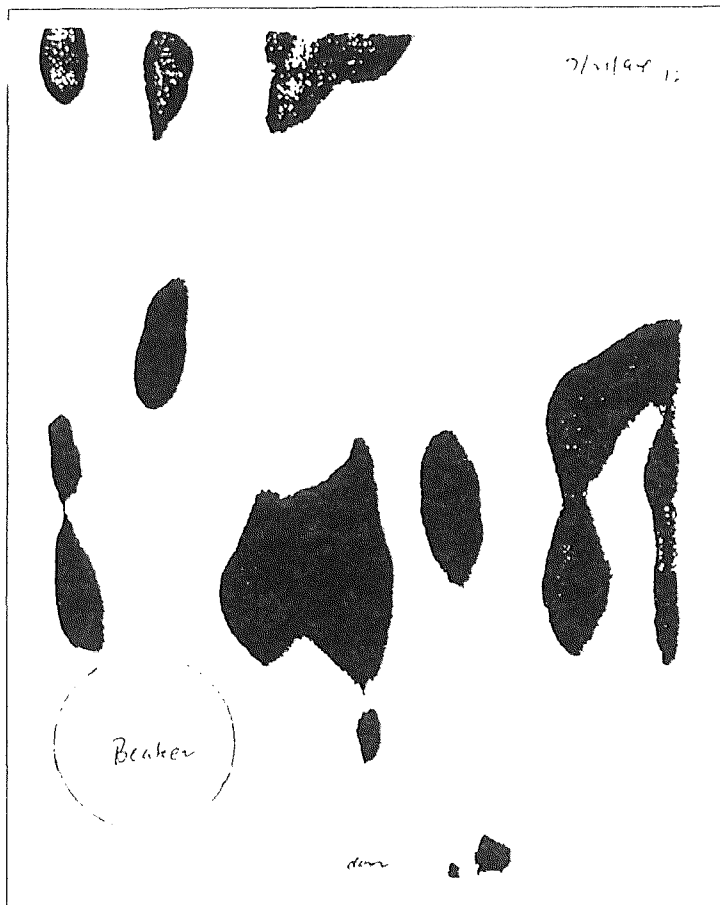

Figure B.5 cw = 2.45 GHz. The load with 100 ml water in position (b), exposure time = 25 sec.

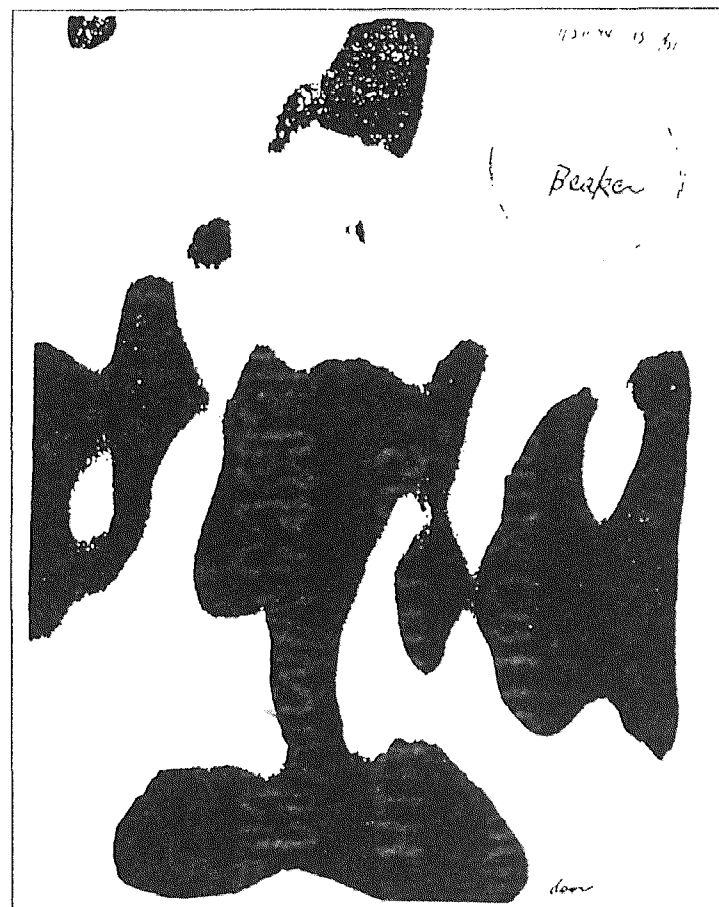
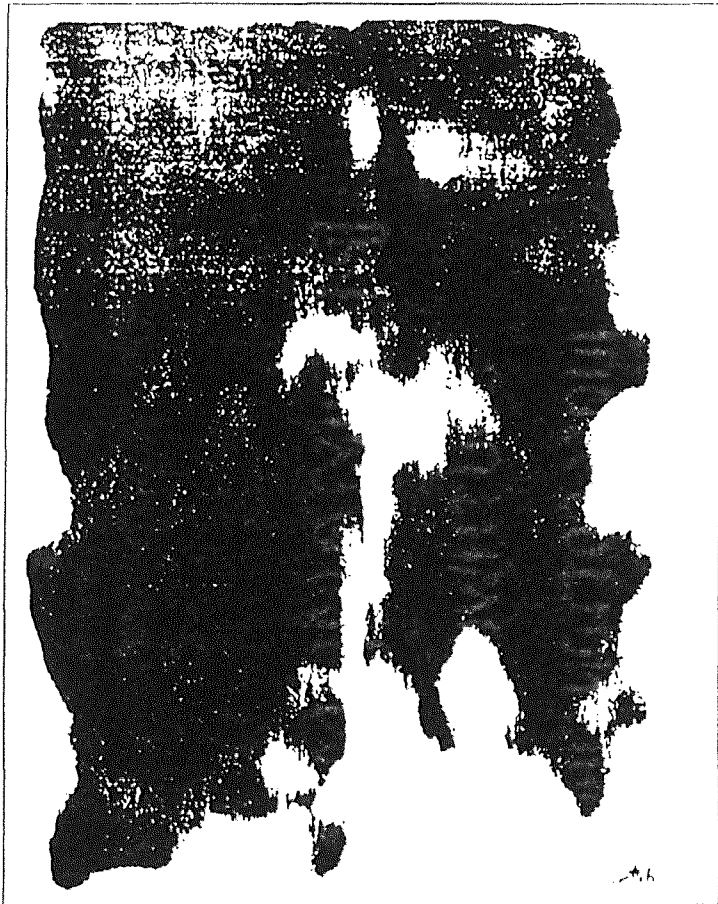
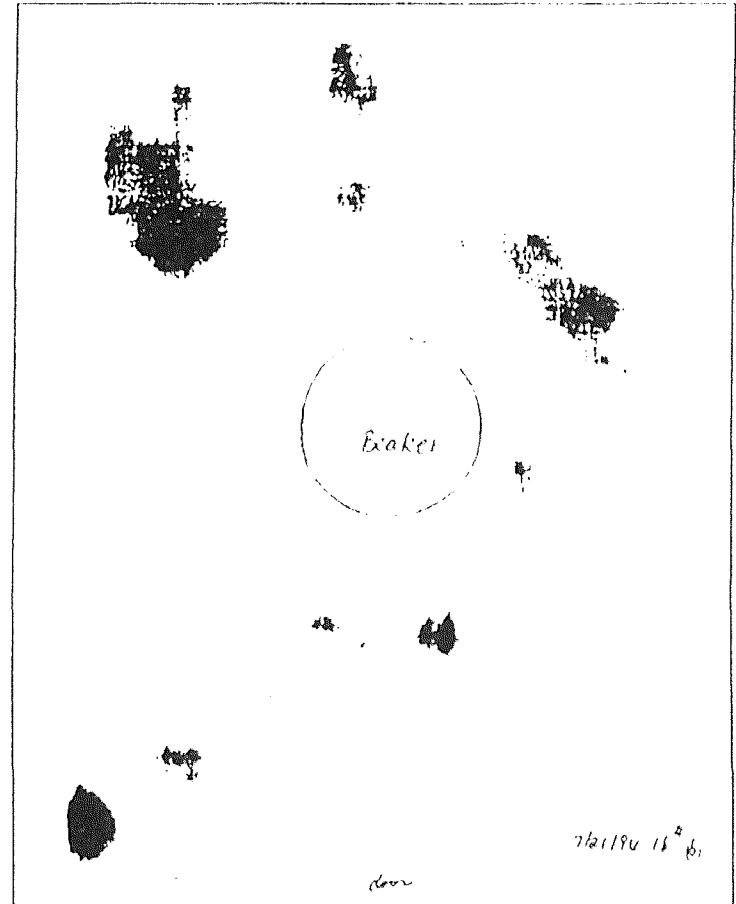

Figure B.6 cw = 2.45 GHz. The load with 100 ml water in position (c), exposure time = 25 sec.



**Figure B.7** 2.40--7.50 GHz, sw=0.1 sec. Exposure time = 40 sec. No load .



**Figure B.8** 2.40--7.50 GHz, sw=0.1 sec. The load with 100 ml water in position (a). Exposure time = 40 sec.

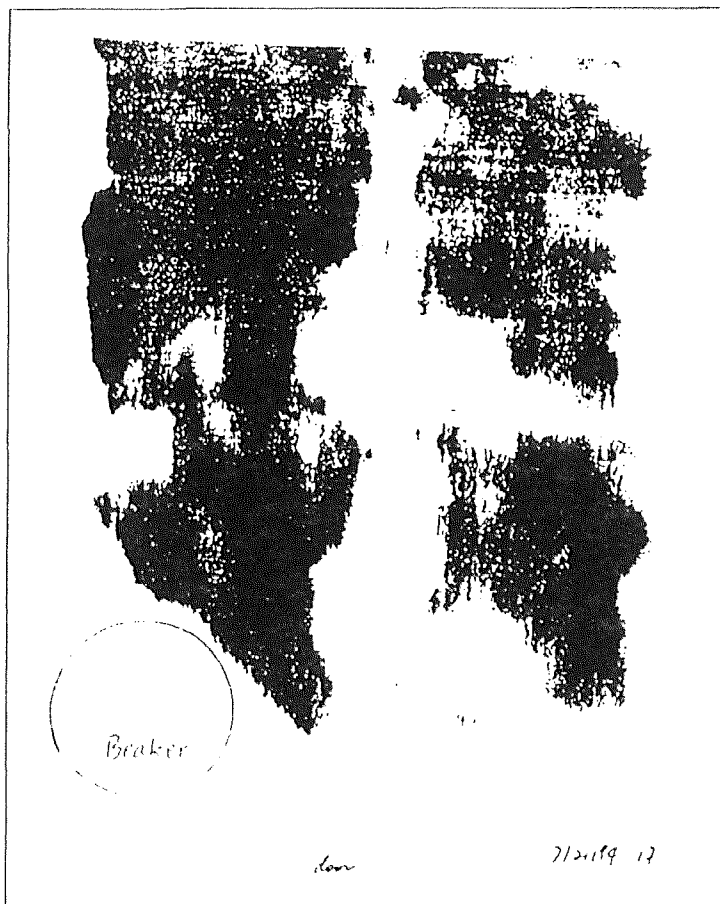

**Figure B.9** 2.40--7.50 GHz, sw=0.1 sec. The load with 100 ml water in position (b). Exposure time = 40 sec.

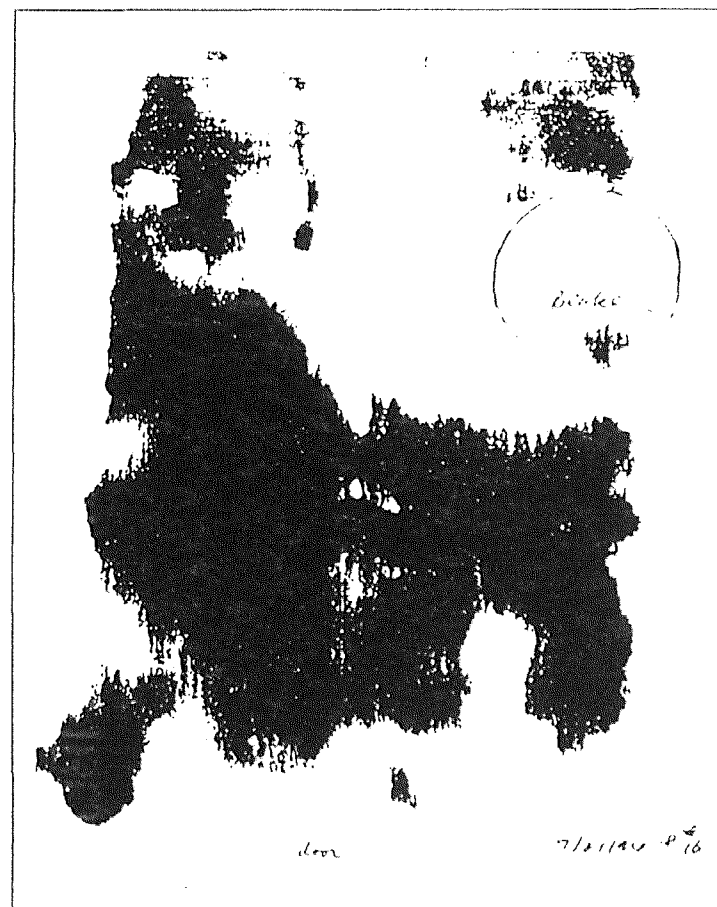

**Figure B.10** 2.40--7.50 GHz, sw=0.1 sec. The load with 100 ml water in position (c). Exposure time = 40 sec.



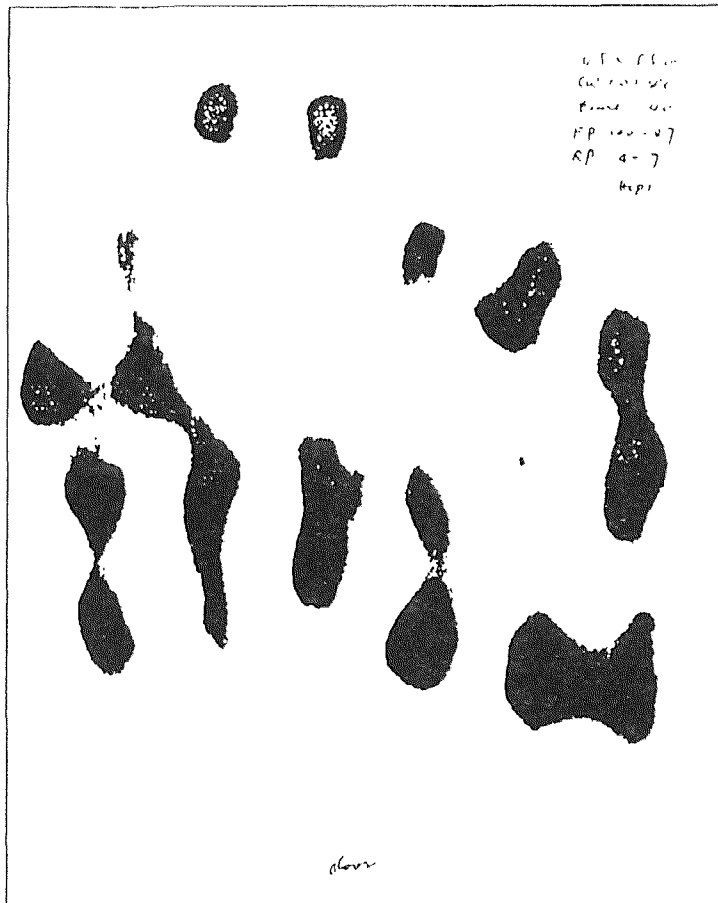

Figure B.11 4.5--5.5 GHz, sw=0.1 sec. Exposure time = 40 sec.

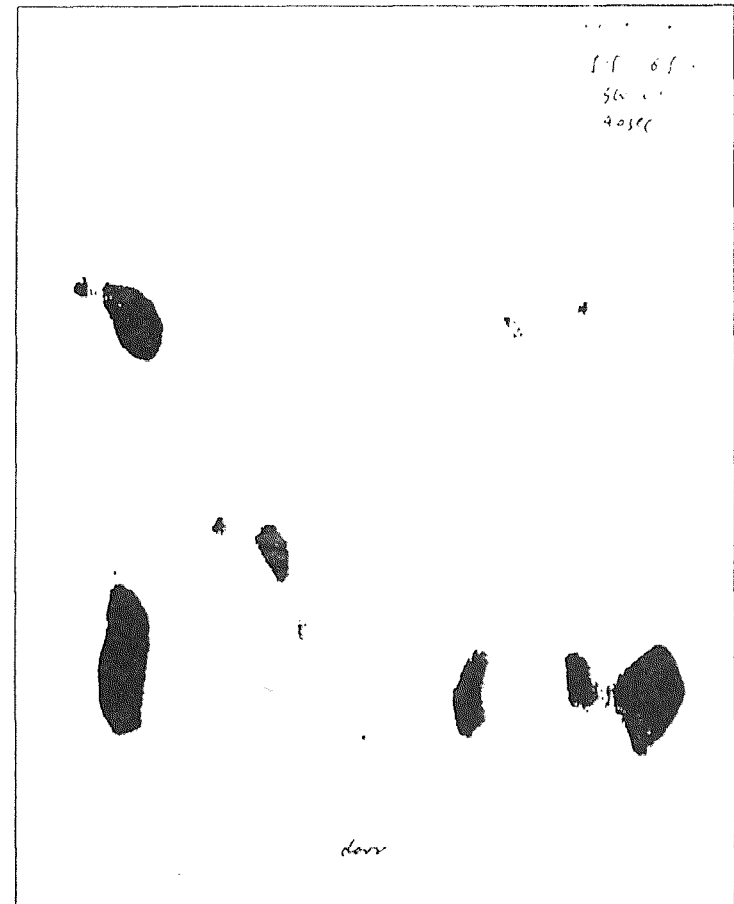

Figure B.12 5.5--6.5 GHz, sw=0.1 sec. Exposure time = 40 sec.

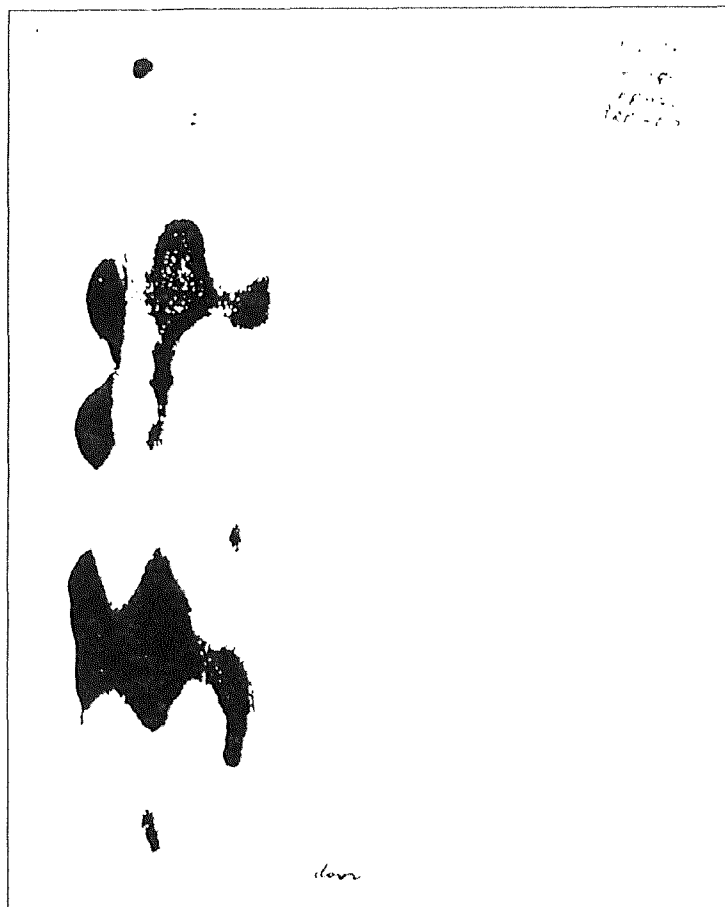

Figure B.13 6.5--7.5 GHz, sw=0.1 sec. Exposure time = 55 sec.

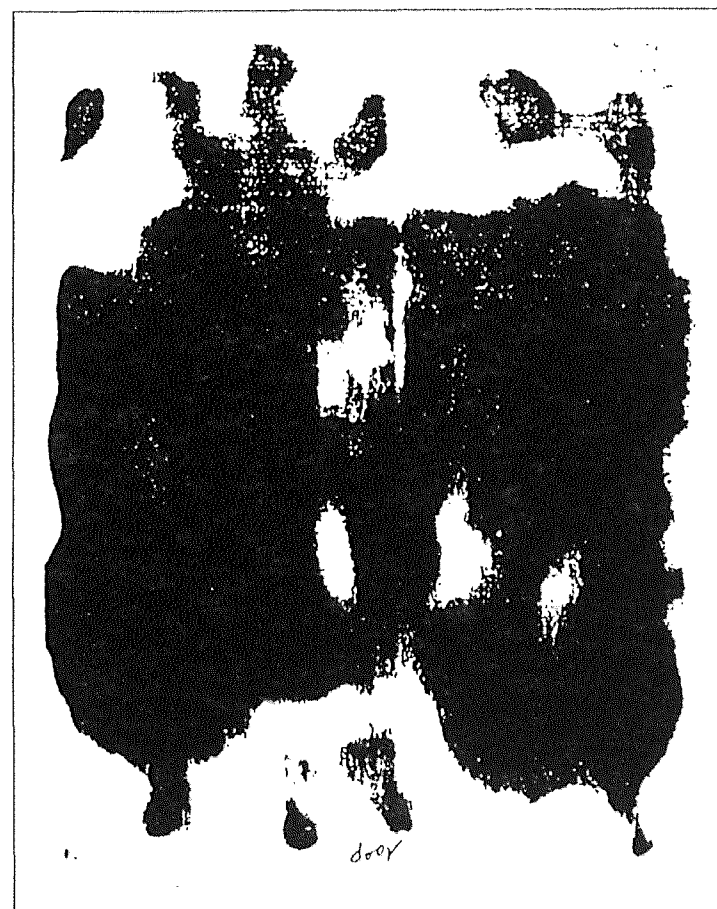

Figure B.14 4.5--6.5 GHz, sw=0.1 sec. Exposure time = 1 min.

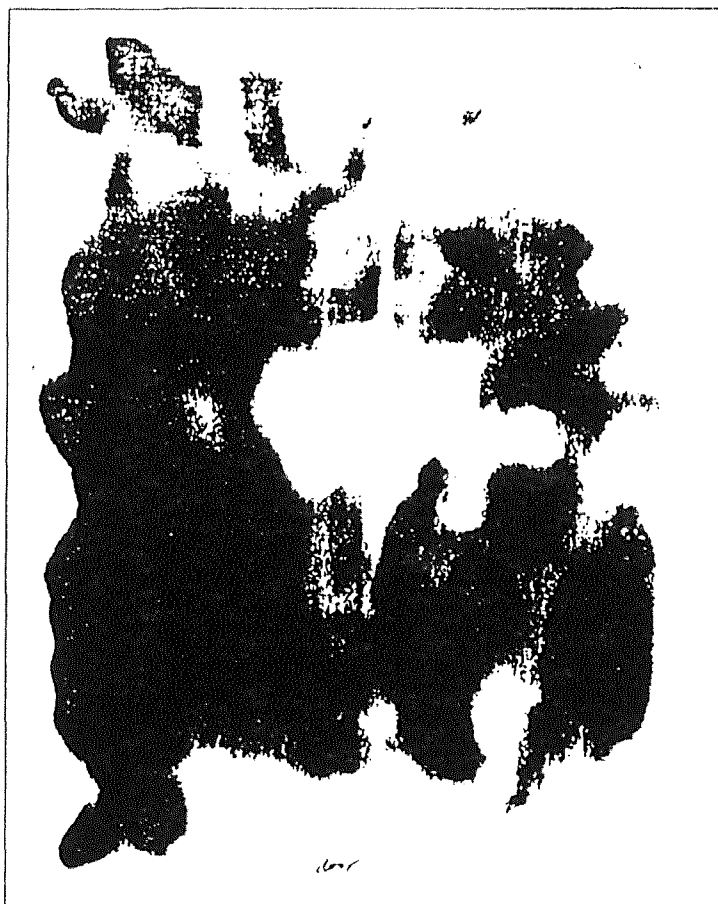

Figure B.15 5.5--7.5 GHz, sw=0.1 sec. Exposure time = 1 min.

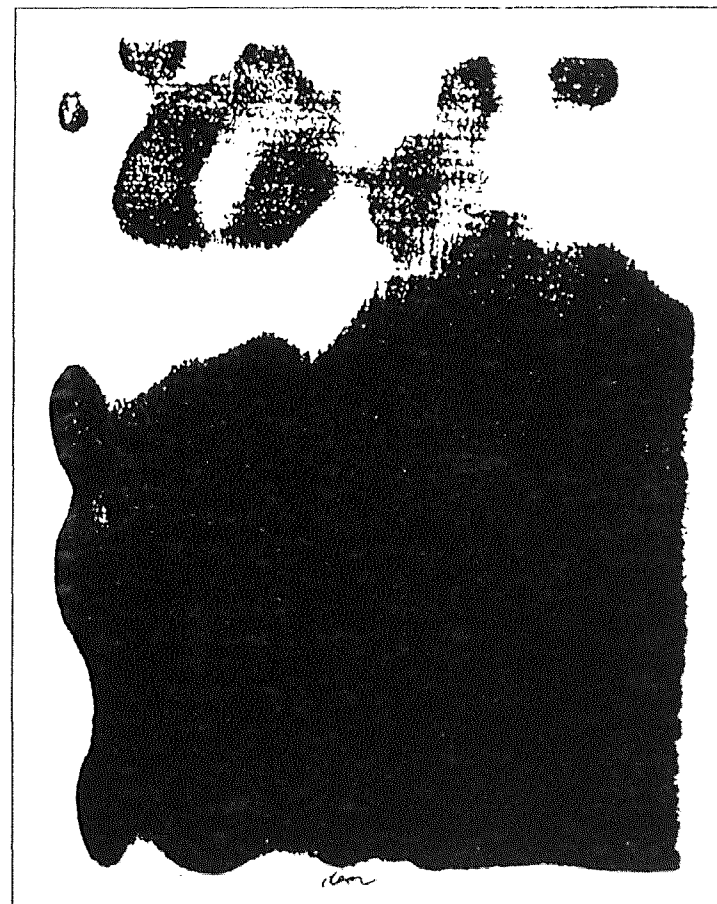

Figure B.16 4.5--5.5 GHz, sw=0.1 sec. Exposure time = 2 min. Two layers of Teledeltos paper at different height.

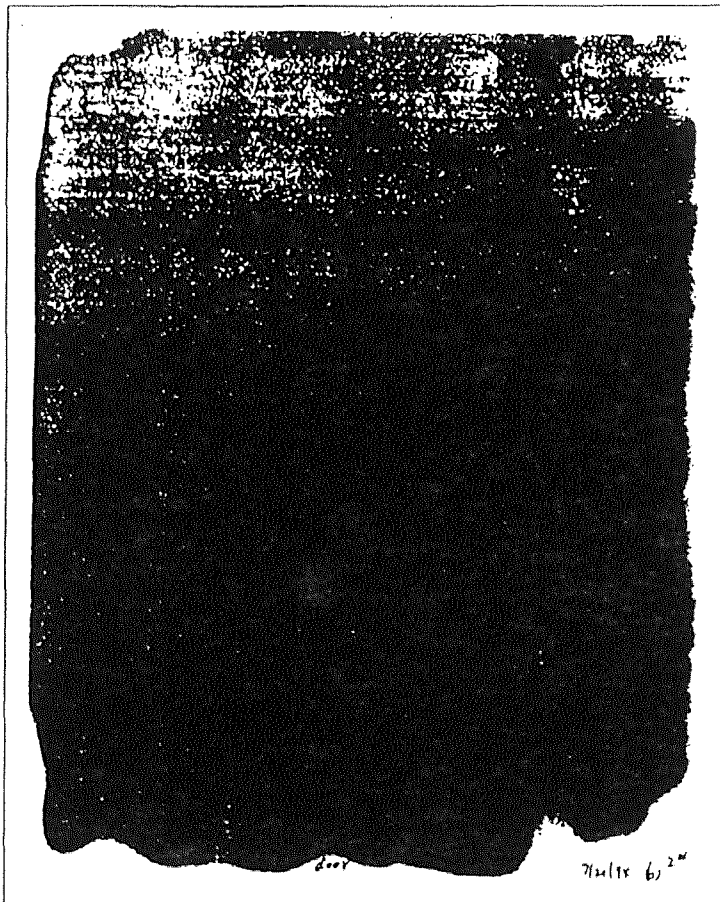

Figure B.17 4.5--5.5 GHz, sw=0.1 sec. Exposure time = 1 min. No load.

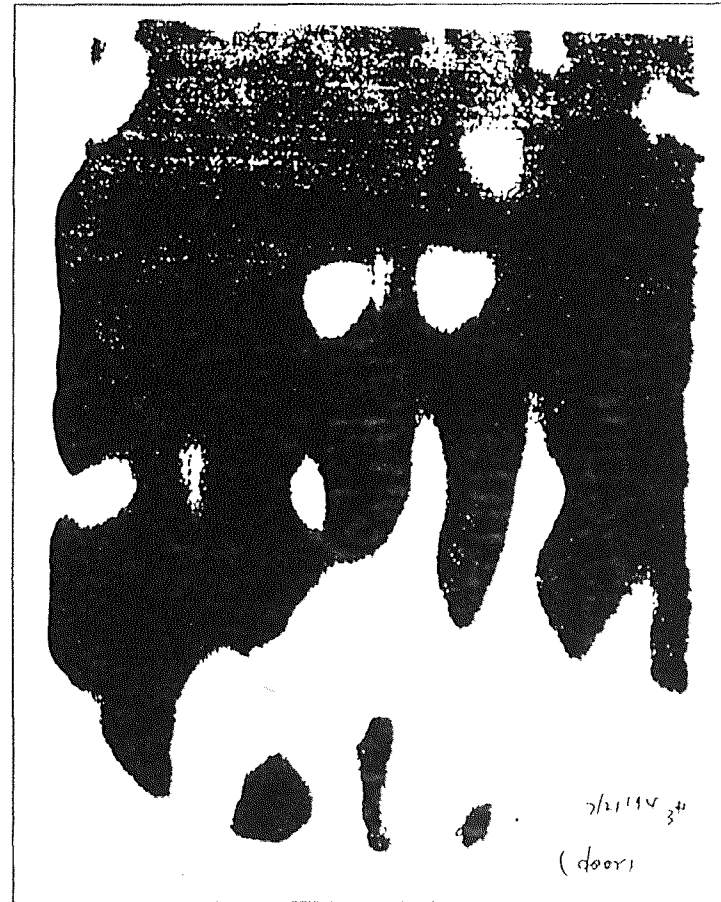
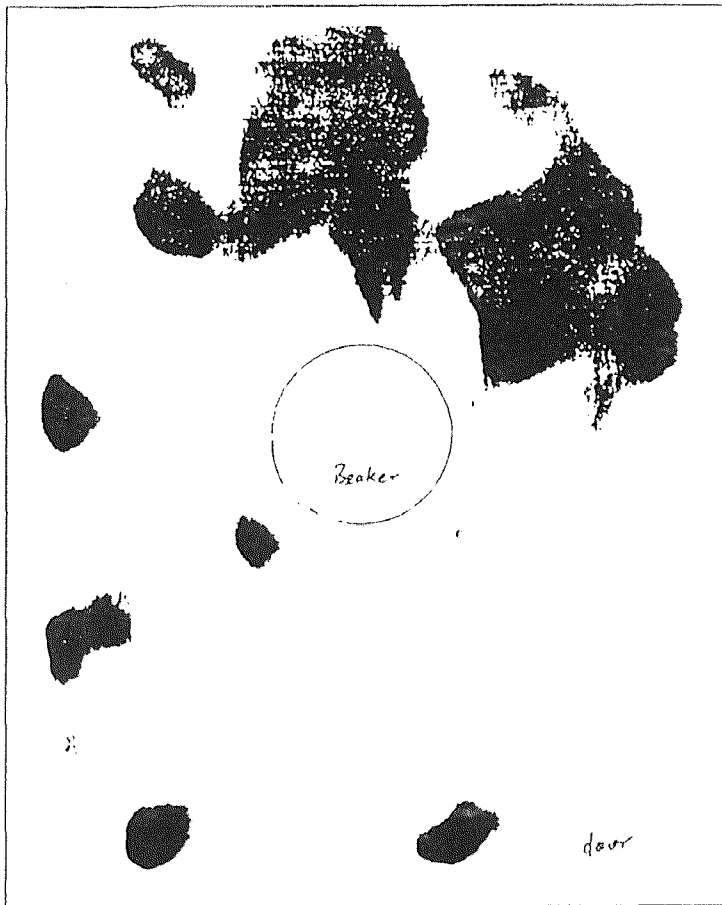
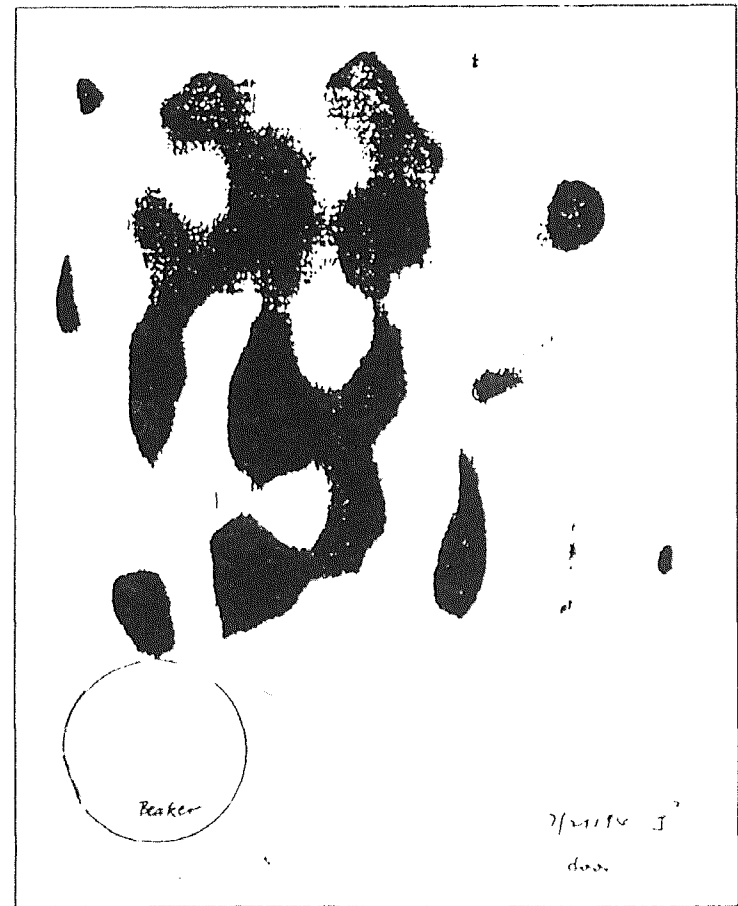

Figure B.18 4.5--5.5 GHz, sw=0.1 sec. Exposure time = 40 sec. No load.



**Figure B.19** 4.5--5.5 GHz, sw=0.1 sec. The load with 100 ml water in position (a). Exposure time = 40 sec.



**Figure B.20** 4.5--5.5 GHz, sw=0.1 sec. The load with 100 ml water in position (b). Exposure time = 40 sec.

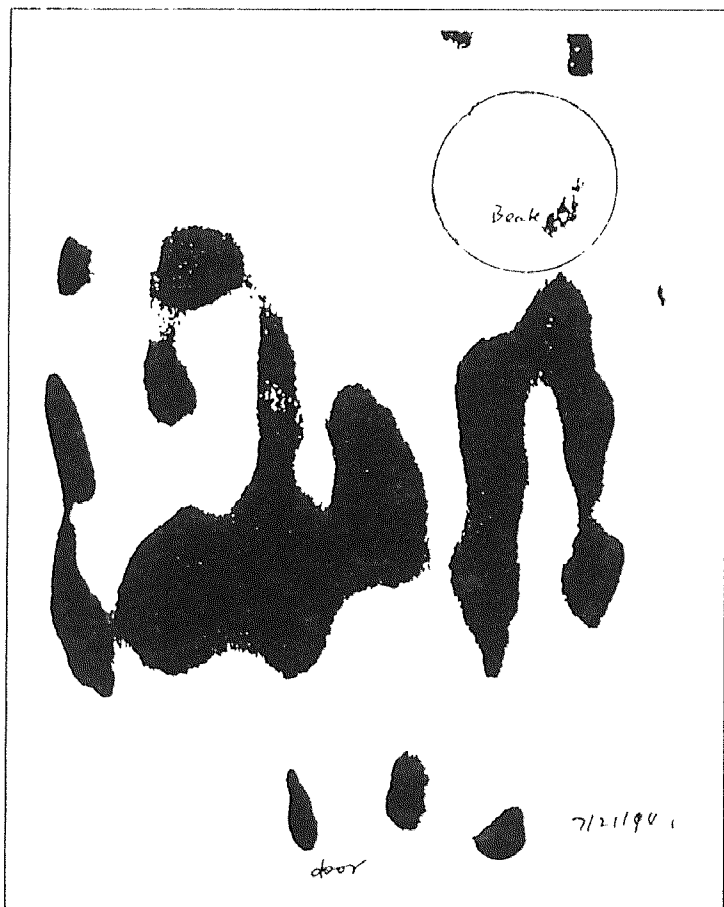

Figure B.21 4.5--5.5 GHz, sw=0.1 sec. The load with 100 ml water in position (c). Exposure time = 40 sec.

## REFERENCES

- Carter, Martin R. 1993. *Soil Sampling and Methods of Analysis*. Lewis Publishers, Boca Raton. 499-500.
- Darmiento, F.T. 1994. "Managing PCB Risk & Liability." *The National Environmental Journal* . 4: 26.
- Foth, H.D. and Turk, L.M. 1972. *Foundamental of Soil Science*. Fifth Edition. NewYork: John Wiley & Sons: 65-66.
- Gan, D. R. 1994. "Disapperance and Crop Uptake of PCBs from Sludge-Amended Farmland." *Water Environment Reseach*. Vol.66. No.1: 55-56.
- Gardiol, Frede. 1984. *Introduction to Microwaves*. New York: Artech House. 1-7
- Gibson, J.S. 1970. *Soils - Their Nature, Classes, Distribution, Uses, and Care*. University of Alabama Press.
- Gu, Huping. 1990. "The Application of Microwave Technology to the Remediation of Non-Volatile Organic-Contaminated Soil." MS. Thesis. New Jersey Institute of Technology.
- Grünewald, M. Rudolf. 1981. "Measurement of Temperature and Temperature Distribution in the Microwave Field." German. *ZFL* 32, 3: 85-88.
- HSFS. 1989. "Polychlorinated Biphenyls." *Hazardous Substance Fact Sheet*. New Jersey: Department of Health.
- IARC. 1978. "Monographs on the Evaluation of the Carcinogenic Risk of Chemicals to Humans ." Lyon. Vol.18. 43-99.
- Johnson, A.C. 1993. "Frequency Microwave Furnace for Large-Area, Uniform Processing." *Amer. Cer. Soc. Symp. Proc.*
- . 1993. "Use of Variable Frequency Microwave power to Achieve Uniformity Results Throughout Large Volumes for Material Processing." Published in *Industrial Microwave Power Institute Symposium Proceedings*.
- Karasek, F. W. 1988. *Basic Gas Chromatography-Mass Spectrometry Principles and Techniques*. New York: Elsevier Science Publishing Company. Chapter 1, 2, 4.

- Kirk-Othmer. 1991. *Encyclopedia of Chemical Technology*. (Executive editor, Jacqueline I.K., Editor, Mary Howe-Grant). 4th Edition. New York: Wiley. Vol.6:127-133.
- Klaassen, C.D. *et al.* 1986. *Toxicology the Basic Science of Poisons*. 3rd Edition. NY: Macmillan Publishing Company. 840 -720.
- Lauber, J.K. 1986. "Disposal and Destruction of Waste PCBs." *PCBs and Environment* (John S. Waid Editor). Florida: Boca Raton. CRC Press. Vol.3.
- McFarland, V.A. & Clarke, J.U. 1989. "Environmental Occurrence, Abundance, and Potential Toxicity of Polychlorinated Biphenyl Congeners: Considerations for A Congener-Specific Analysis." *Environmental Health Perspectives*. 81: 225-239.
- Mclearn, M. 1988. "Managing PCB Spills." *Pollution Engineering*, Vol xx, No. 6: 50-52.
- McLoy, D.E. 1989. "PCB Wastes." *Standard Hand Book of Hazardous Waste Treatment and Disposal*. (Freeman, Editor). New York: McGraw-Hill, Inc. 4.19.
- Message, Gordon M. 1984. *Practical Aspects of Gas Chromatography / Mass Spectrometry*. New York: Wiley. Chapter 1
- MSDS. 1992. "Polychlorinated Biphenyls (PCBs)." *Material Safety Data Sheets*. Genuim Publishing Corporation. No. 683.
- O'Neill, M.W., *et al.* 1993. "In Situ Treatment of Soil for the Extraction of Organic Contaminants." *Environmental Progress*. Vol.12. No.1: 13.
- Peterson, R. L. and G.P. Adams. 1985. " Non-Sodium Process for Removal of PCBs from Contaminated Transfer Oil." Presented at the 1985 *EPRI PCB Seminar*. Seattle. WA. 22-25.
- Roddy, D. 1986. *Microwave Technology*. New Jersey: A Reston Book Prentice-Hall. 521-524.
- Roges, Jean A., Tedaldi, D. J. & Kavanaugh M. C. 1993. "A Screening Protocol for Bioremediation of Contaminated Soil". *Environmental Progress*. Vol.12. No. 2:19.
- Windegasse, Garbrel. 1984 "A New Hazardous Waste Treatment Technology Utilizing Low Power Density Microwave energy." MS. Thesis. New Jersey Institute of Technology.
- Woodyard, J.P. 1990. "PCB Detoxification Technologies: A Critical Assessment." *Environmental Progress*. Vol.9. No.2: 131-135.



Zhu, Naihong. 1991. "Microwave Treatment of Hazardous Wastes: Chemical Fixation of Insoluble No-Volatile Chemically No-Reactive Organic in Soil." MS. Thesis. New Jersey Institute of Technology.